

## The Synthesis and Characterization of a New Family of Polyamide Dendrimers

Peter R. Ashton, Derek W. Anderson, Christopher L. Brown, Andrew N. Shipway, J. Fraser Stoddart,\* and Malcolm S. Tolley

**Abstract:** A new family of dendrimers has been constructed with 5-hydroxyisophthalic acid and diethanolamine as the sources of the branching units. The design of a second-generation building block in the form of an orthogonally-protected aminotetraacid (a single diethylphosphoramidate-protected amine and four methyl-ester-protected carboxylic acid groups) has been established by a series of logical developments involving the synthesis of various dendrimer prototypes. This building block has been utilized in both convergent and divergent methods in the synthesis of mono-

disperse dendrimers up to the fourth generation and subsequently polydisperse sixth-generation dendrimers at the level of a mixture. One-, two-, and three-directional dendrimers of the second and fourth generation were synthesized in order to carry out detailed comparisons by GPC and by  $^1\text{H}$  NMR spectroscopy. The GPC results suggest that the fourth-generation dendrimers

adopt globular shapes, while the variable-temperature NMR spectroscopic investigations demonstrate that the periphery of the fourth-generation dendrimer is less mobile than either of its internal regions or the analogous portions of the second-generation dendrimer. Molecular modeling suggests highly globular shapes for the larger dendrimers and gives values for molecular radii in very close agreement with those obtained from analysis of the GPC results.

**Keywords:** amino polyacids • branched monomers • copolymerizations • dendrimers • polymers

### Introduction

Recently, dendrimers have attracted a lot of attention from researchers<sup>[1]</sup> for a variety of reasons. Some dendrimers are being produced commercially<sup>[2]</sup> in multikilogram quantities, while others are showing promise in fields as diverse as enantioselective catalyses<sup>[3]</sup> and drug delivery systems.<sup>[4]</sup> Their potential applications<sup>[5]</sup> rely, to a large extent, on their unique topologies<sup>[6]</sup> and on the properties<sup>[7]</sup> dictated by their highly branched structures. Medium- to large-sized dendrimers adopt globular conformations in which sizable cavities are located beneath their tightly packed surfaces. The specific

shapes of these cavities and their containment characteristics are expected<sup>[8]</sup> to confer useful properties. Although dendrimers have been evaluated by many different methods, including electron microscopy,<sup>[9]</sup> ESR spectrometry,<sup>[10]</sup>  $^{13}\text{C}$  nuclear relaxation measurements<sup>[11]</sup> and solvatochromic studies,<sup>[12]</sup> the direct observation and assessment of dendritic topology is difficult. Computer modeling studies<sup>[13]</sup> have probably provided the best graphic displays of dendrimers so far. In our own recent research, reported in this paper, we have used the technique of variable-temperature NMR spectroscopy to study the dynamic processes within the dendritic structures and to establish the relationship between these processes and the size of the dendrimer. Further, we have related our findings to results obtained from both gel permeation chromatography and molecular modeling studies.

The construction of dendrimers has been dominated by two antithetical philosophies, the convergent<sup>[14]</sup> and the divergent<sup>[15]</sup> ones. While the divergent approach involves building the dendrimer outwards starting from a core, the convergent approach begins with what will ultimately be the periphery of the dendrimer, and entails building inwards to the core. Both methods require two steps for the growth of each generation: the activation of the growing dendritic fragment, and the addition of new monomer units; both methods have their

[\*] Prof J. F. Stoddart,<sup>[+]</sup> P. R. Ashton, Dr C. L. Brown, Dr A. N. Shipway, M. S. Tolley

School of Chemistry, The University of Birmingham  
Edgbaston, Birmingham B15 2TT (UK)

Dr D. W. Anderson  
Chemical and Biological Defence Establishment  
Porton Down, Wiltshire SP4 0JQ (UK)

[+] Current address: Department of Chemistry and Biochemistry  
University of California at Los Angeles  
405 Hilgard Avenue, Los Angeles, CA90095 (USA)  
Fax: (+1) 310-206-1843  
E-mail: stoddart@chem.ucla.edu

strengths and weaknesses. The possibly more widely used method, the divergent approach, has been dogged by polydispersity,<sup>[16]</sup> which arises from incomplete reaction and purification problems. While polydispersity does not constitute a significant setback in a materials context for applications, it is associated with inseparable mixtures of macromolecules that become almost impossible to modify chemically in a highly controlled manner. The alternative convergent approach is preferred for the preparation of monodisperse samples, and has been utilized<sup>[17]</sup> in the construction of dendrimers that have subsequently been subjected to precisely controlled chemical modifications. Convergent syntheses can, however, suffer<sup>[18]</sup> from low yields that are often attributed to steric hindrance at the focal points of large wedges. In addition, they are less easily scaled up, since even a quantitative yield in a generation-adding step adds very little to the sample mass, whereas a divergently-added generation more than doubles the mass of a dendrimer. While the convergent and divergent approaches have been used extensively<sup>[19]</sup> to incorporate a wide variety of structural entities into dendrimers, the problem remains that each synthesis is only specific to one particular dendrimer. Better methodologies for the accelerated construction of constitutionally pure dendrimers have been developed in response to the need for more time-efficient syntheses. Although methodologies such as the use of hypercores,<sup>[20]</sup> branched monomers,<sup>[21]</sup> and a two-step approach<sup>[22]</sup> have appeared, they offer limited opportunities with respect to flexibility of constitutional control. What is required is a more general synthetic strategy that affords maximum flexibility in relation to the constitution, without leading to an increase in the number of synthetic steps.

Moore<sup>[23]</sup> has described a double-exponential strategy in which the construction of dendrimers is actually more convergent in a synthetic sense. In this strategy, orthogonal protecting groups on either end of the monomer are removed selectively, and the two different products that result are reacted subsequently with each other to produce a new, larger branching unit. This approach gives access to macromolecular structures in just a few steps and, after each growth step, the dendritic product is an analogue of the original monomer.

Any dendritic system relies essentially<sup>[24]</sup> on just one reaction for the linking of its branching units. This fact not only emphasizes just how important the choice of that reaction is, but also has serious implications if one is interested in subtle engineering<sup>[25]</sup> of the dendritic architecture.

We present here the development of a building block for the construction of dendrimers which offers a high degree of versatility. By means of well-known protection/deprotection reactions and an amide-bond-forming growth reaction, this unit is capable of growth in either the convergent or the divergent direction, and can thus be considered a double exponential building block. The basic building block is also of interest due to its doubly branched structure. It is a second-generation monomer as its reaction with a dendritic fragment increases the number of generations by two. Furthermore, the two generations are of entirely different constitutions, leading to a final dendrimer with “alternating shell” topology and diverse functionality.

## Results and Discussion

Much of any dendritic structure is composed of branching moieties, and so considerable care has to be taken in their choice. Branching is usually<sup>[26]</sup> incorporated into the monomer unit, although it can be achieved<sup>[27]</sup> during the dendrimer growth step from a nonbranched monomer. We made an early decision to choose branching monomers which are linked by a nonbranching reaction, as this gave us with a wider choice of reactions for joining the units. There has been a great deal of success<sup>[28]</sup> in the synthesis of application-oriented dendrimers designed around specific branching units.

For our purposes, we were interested ultimately in the dendrimer functioning as a host molecule, and so we chose branching units which might provide sites for noncovalent bonding interactions. We identified two starting materials—namely, diethanolamine (**1**) and 5-hydroxyisophthalic acid (**2**, Figure 1)—which could be used to introduce branching into

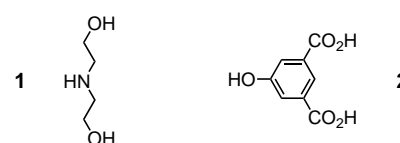
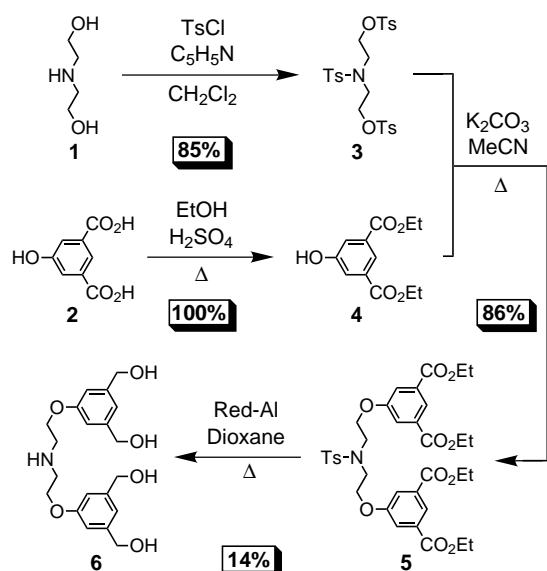

Figure 1. Branched starting materials for the construction of a dendritic building block.

the structure. The units incorporated possible hydrogen-bonding sites together with a  $\pi$ -electron aromatic system. By creating an oligomer composed of two units, we anticipate the emergence of a method with several advantages over more traditional ones (which involve only one branching moiety). Firstly, the basic building block would be a branched monomer<sup>[29]</sup> of the second generation, that is, it branches twice, and would add two generations to a growing dendritic fragment. Very fast growth should be achievable, thus countering one of the much-cited<sup>[30]</sup> weaknesses of many dendrimer syntheses. Secondly, we would create a dendrimer with an interesting topology. Internal functionality would be more diverse than is the case in many dendrimers, and the dendrimer would consist of alternating shells, a structure described<sup>[31]</sup> as a dendritic layer–block copolymer. Following the synthesis of an appropriate dendritic building block, the linking of these units to create larger structures then had to be addressed—and was.

**Synthesis of a double-branched unit:** The building block **6** was synthesized in four steps from diethanolamine and 5-hydroxyisophthalic acid (Scheme 1). This unit has a reactive functionality (an amine) at its focal point and relatively passive benzyl alcohols on its surface. The synthesis of the precursor **5** was achieved readily, requiring no column chromatography; these reactions were performed easily on a 100 mmol scale. The Williamson ether coupling of **3** with **4** was found to give only a 14% yield of compound **5** when two molar equivalents of the phenol were used. This yield was raised to 86% by the use of four molar equivalents of **4**, the excess of which could be recovered easily. Since the reduction of **5** with lithium aluminum hydride in THF was unsuccessful, owing to



Scheme 1. Synthesis of the double-branching unit **6** from diethanolamine and 5-hydroxyisophthalic acid.

solubility difficulties and the low reactivity of the sulfonamide, the reducing agent was changed to sodium bis(2-methoxyethoxy)aluminum hydride<sup>[32]</sup> (Red-Al), and the solvent to 1,4-dioxane. While these conditions were found to cleave the phenyl ethers, reaction with the tosyl protecting group was even faster, allowing isolation of the branching unit **6** in 14% yield when the reaction was quenched after 20 hours. Purification of the highly polar product (**6**) from the reaction mixture proved extremely difficult and an analytically pure sample was not isolated. It seems that the low yield can be attributed in part to the technical problems associated with isolating the product from the crude reaction mixture. Alternative deprotections<sup>[33]</sup> of the tosyl protecting group were found to be unsatisfactory.

The low yield obtained in the synthesis of **6** served to cast serious doubts over its use in the construction of dendrimers. Its preparation, which requires column chromatography and suffers from a low yield, would be a serious handicap even before dendrimer construction began. In addition, **6** is only sparingly soluble in aprotic solvents, leading to difficulty in its use and similar properties in the dendrimers we could construct from it. We have shown, however, that a diethanolamine/5-hydroxyisophthalic acid-based dendritic branching unit can be prepared, and we hope that small design changes in this prototype might permit the development of a more feasible system for the production of dendrimers on a useful scale.

**The production of a small dendrimer:** The problems associated with the branching unit **6** are dominated by its poor solubility as well as by the difficulty encountered in the deprotection of the amino function. We therefore aimed to make a more lipophilic analogue which did not require such a demanding deprotection. Our solution to these problems (Scheme 2) was to utilize a more labile nitrogen-protecting group and to perform the reduction of the ester groups much earlier in the synthesis. The latter modification also allowed us

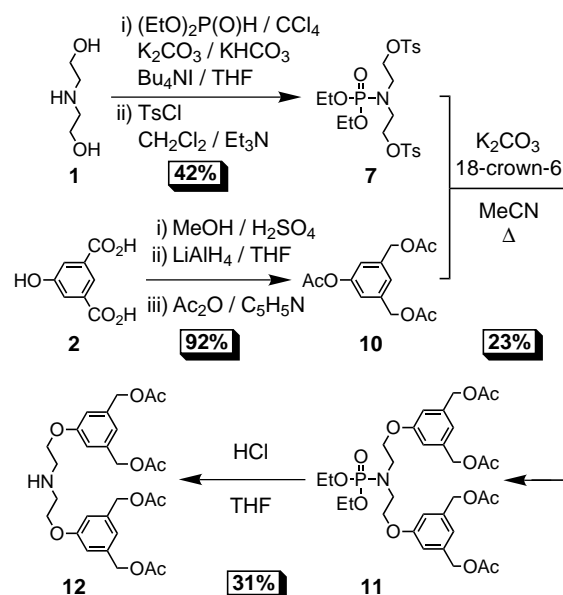

Scheme 2. Synthesis of the improved double-branching unit **12**.

to mask the four hydroxyl groups with protecting groups that could be readily removed when the free alcohols were required. Scheme 2 shows the successful route to the acyl-protected monomer **12**.

The choice of the amino protecting group turned out to be particularly crucial with respect to decomposition<sup>[34]</sup> and elimination reactions in the ether-forming step. The diethylphosphoryl protecting group, used<sup>[35]</sup> in the construction of aza-crown ethers, was chosen after an investigation of more traditional candidates. The phosphoramidate was formed under basic conditions and was removed with anhydrous hydrogen chloride. Protection of diethanolamine<sup>[36]</sup> (**1**) using diethylphosphite followed a literature method, and the crude product was tosylated to afford **7** in a yield of 42% for the two steps. The triacetate **10** was obtained from 5-hydroxyisophthalic acid (**2**), via **8** and **9** in an overall yield of 92% over three steps. The reaction of **10** with **7** to give the double-branched unit **11** occurred in only a 23% yield. Although it is known<sup>[37]</sup> that that carbonate ion in refluxing THF or MeCN can deprotect acylated phenols, generating a phenoxide ion, this reaction is slow, and by-products from the desired ether synthesis are formed as a result of the elimination of TsOH and the nucleophilic attack<sup>[38]</sup> of acetate on **7**. Deprotection of the diethylphosphite-protected branching unit **11** occurred in a 31% yield to give the new branching unit **12** as a thick, colorless oil. By-products from the deprotection can be attributed to cleavage of the phenyl ethers, and so the reaction must be followed carefully in order to maximize the yield.

The synthesis of a second-generation dendrimer was performed as a demonstration of the use of the new branching unit **12** in dendrimer synthesis (Scheme 3). Benzene 1,3,5-tricarbonyl trichloride was utilized as a three-directional core with which the (amine) focal points of three branching units could form an amide bond. The acyl-protected dendrimer **13** was obtained in 64% yield after column chromatography, and the subsequent deprotection of all twelve benzylic hydroxyl groups with NaOMe in MeOH gave an 86% yield of the

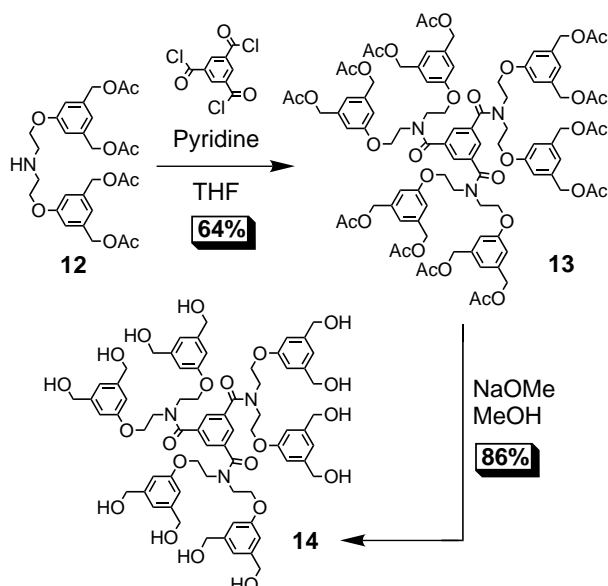

Scheme 3. Synthesis of the deprotected second-generation dendrimer **14** from the improved double-branching unit.

three-directional second-generation dendrimer **14**. The dendrimer was a glassy solid, with a molecular mass of 1287 Da, and was soluble in polar solvents. The  $^1\text{H}$  NMR spectra recorded at 273 K and 300 MHz for both the protected and the deprotected dendrimers were broad as a consequence of hindered rotation about the amide bond. However, at 373 K and 400 MHz, amide bond rotation is fast on the  $^1\text{H}$  NMR timescale, leading to sharp spectra and hence making characterization easier.

**The synthesis of a new family of dendrimers:** Although we had been able to demonstrate the use of **11** as a branching unit, the dendritic system that was developed had little potential for the construction of large, highly designed macromolecules. Our next objective was to develop the system to allow more flexibility in dendrimer construction. Considering our earlier experiences, we were struck by the possibility that we might be able to create a double exponential-type building block from two branching synthons that we had synthesized previously. To this end, reaction of the phenol **8** with the bistosylate **7** afforded the diethylphosphite-protected tetramethyl ester **15** (Scheme 4) in a yield of 84%.

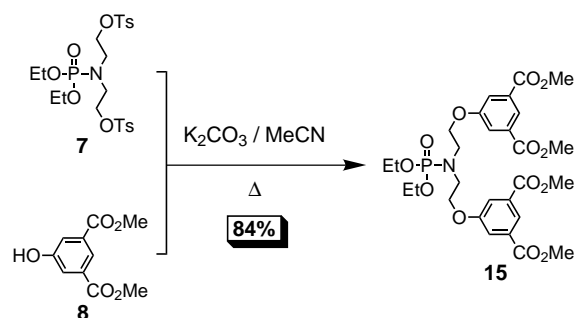

Scheme 4. Synthesis of the orthogonally protected dendrimer building block **15**.

The double-branching unit **15** can be considered an orthogonally-protected amino tetraacid, ideal for use as a versatile dendritic building block. Reactions involving the formation of amide bonds from amines and acids are extremely well known as a consequence of their importance in nature, and they have also been used in previous dendrimer syntheses. Very early in the history of dendrimers, lysine was used as a branching unit by Denkwalter,<sup>[39]</sup> and more recently, glutamic acid<sup>[40]</sup> has also been utilized in the synthesis of dendrimers. Unnatural amino polyacids have also been used as branching units, notably by Shinkai,<sup>[41]</sup> Fréchet,<sup>[42]</sup> and Diederich.<sup>[43]</sup>

The versatility of **15** was established by its use in a double exponential growth step (Scheme 5). The amino function can be deprotected with anhydrous hydrogen chloride in THF,

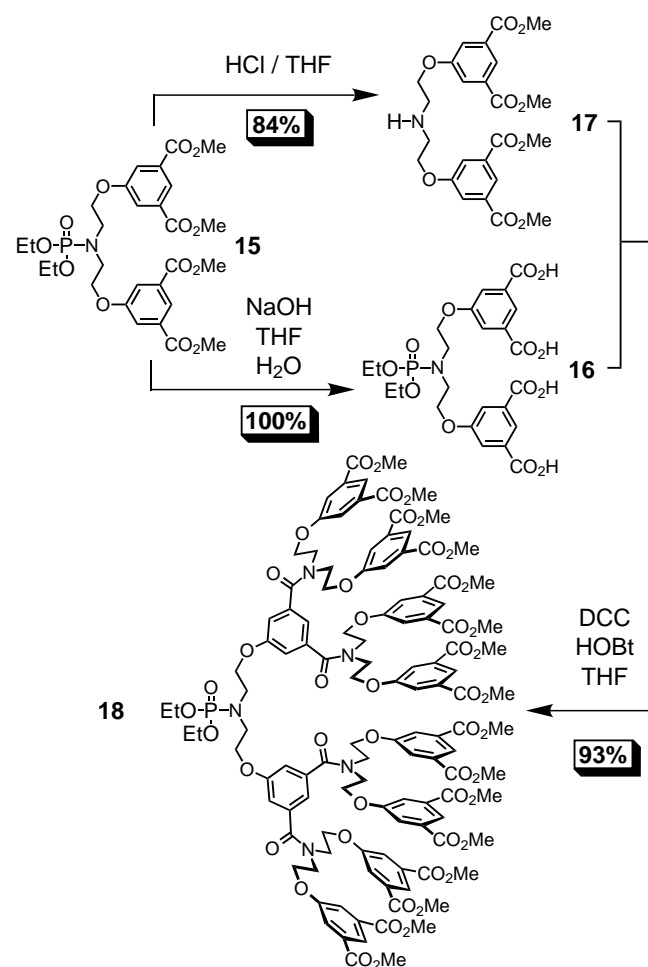

Scheme 5. Use of the building block **15** in a double exponential growth step to form the fourth-generation building block **18**.

and the carboxylic acids with NaOH in refluxing  $\text{H}_2\text{O}/\text{THF}$ . Both reactions proceeded in high yields (84% and 100%, respectively), giving pure products **17** and **16**, respectively, after a single precipitation. In each case, the integrity of the other protecting group is maintained. The amine **17** and tetraacid **16** were coupled in the presence of dicyclohexylcarbodiimide (DCC) and 1-hydroxybenzotriazole (HOBt) to give the fourth-generation wedge **18**. It has a single protected

amine at its focal point, sixteen protected carboxylic acids on its surface, and a molecular mass of ca. 2500 Da. The amine **17** was also treated with trimesic acid (**20**) to give the second-generation dendrimer **19** in 70% yield (Scheme 6). Here, the

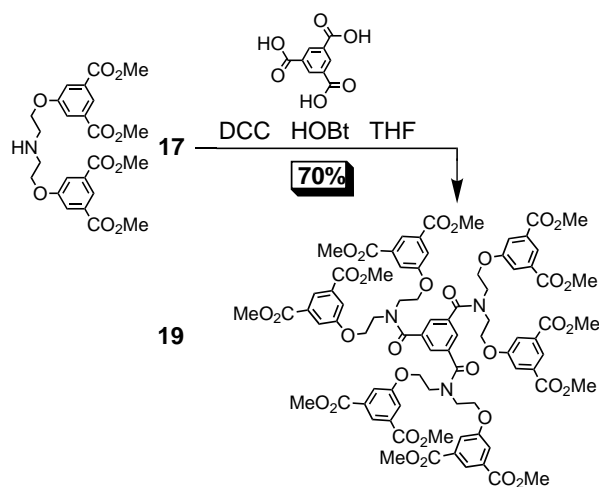

Scheme 6. Synthesis of the second-generation dendrimer **19**.

activated wedge **17** was used as a second-generation wedge to attach to the three-directional core. Dendrimer **19** has a molecular mass of just over 1500 Da, and is terminated with 12 methyl ester functions on its surface.

From here on, in order to illustrate macromolecular structures on the printed page, it will become necessary to represent them as cartoons (Figure 2), in which each of the

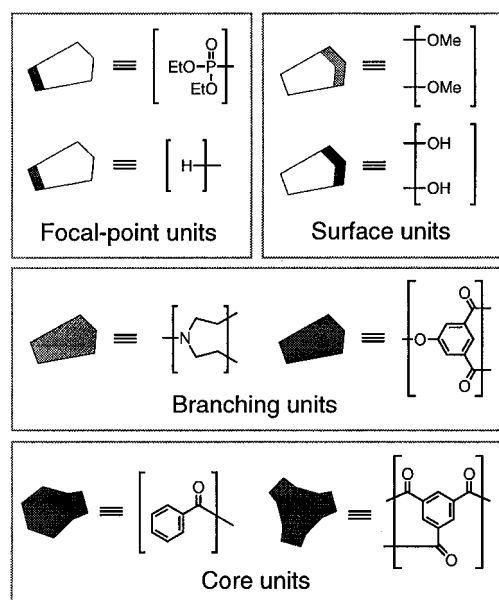

Figure 2. The key to the schematic representations of dendrimers used in this paper.

dendritic branching units is represented by truncated wedge shapes with different shadings. Reactive functionalities are shown as dark shadings, while passive functionalities are shown as light ones. These illustrations allow very large

structures to be drawn concisely and help to clarify subsequent synthetic schemes and diagrams.

By way of introduction, the four reactions shown in detail in Scheme 5 and Scheme 6 are depicted in cartoon form in Scheme 7, along with some further reactions. This depiction clarifies the way in which a controlled structure can be built up in a highly efficient manner from the monomer **15** and the core unit **20**. The second-generation two-directional dendrimer **21** was isolated as a by-product of the three-directional dendrimer-forming reaction to give **19**. This scheme shows us how much larger structures may be built up in very few steps. The construction of two dendrimers from the small dendrimer **19** and the fourth-generation wedge **18** are also shown. The first step in each case is the focal-point deprotection of **18**. This reaction was carried out with anhydrous hydrogen chloride in THF, giving the amine **24** in a yield of 72%. Although side reactions, resulting from ether and amide cleavage, are slow under these conditions, the starting material and the product both contain a very large number of these somewhat reactive bonds. These cleavage reactions can therefore cause a significant loss of yield if the reaction is allowed to run for any longer than is absolutely necessary.

The fourth-generation dendrimer **26** was synthesized by the reaction of the activated wedge **24** with trimesic acid (**20**) under DCC/HOBt coupling conditions (Scheme 7). The product has 48 terminal ester functions, two alternating generation moieties, and a nominal mass of 7108 Da. The yield (13%) was considerably lower than those obtained in previous DCC–HOBt couplings, and a significant quantity (32%) of the disubstituted trimesic acid **25**, a two-directional dendrimer, was isolated. This decrease in yield suggests that steric hindrance plays a significant role in the reaction—an encouraging sign that an interesting topology is being created. An analytically pure sample of the three-directional dendrimer **26** was not isolated from this reaction mixture, since it was readily prepared by the reaction of the fourth-generation wedge **24** with 1,3,5-benzenetricarbonyl trichloride in THF (reaction not shown), which proceeds in the remarkable yield of 63%.

The construction of the sixth-generation dendrimer **27** would be a true demonstration of the versatility of the building block **15**. While a more traditional synthesis would take 12 steps from the monomer to create such a dendrimer, the synthesis starting from **15** requires only seven. Here, the second-generation dendrimer **19** was converted into a second-generation core **22** by the hydrolysis of its 12 surface ester groups. This core was then coupled with the fourth-generation wedge **24** to give sixth-generation products. Since the formation of dendrimer **27** (29000 Da) would require the complete reaction of all 12 core functions, it is perhaps hardly surprising that it does not go to completion. The hydrolysis of dendrimer **19** to the dodecaacid **22** proceeds in excellent yield.

We embarked on this sixth-generation dendrimer-forming reaction not expecting to produce a perfect dendrimer, but to see how far the reaction would proceed and to study the properties of any products that we could isolate. Since the crude reaction mixture defied purification by any form of adsorption chromatography, we decided to study it by gel

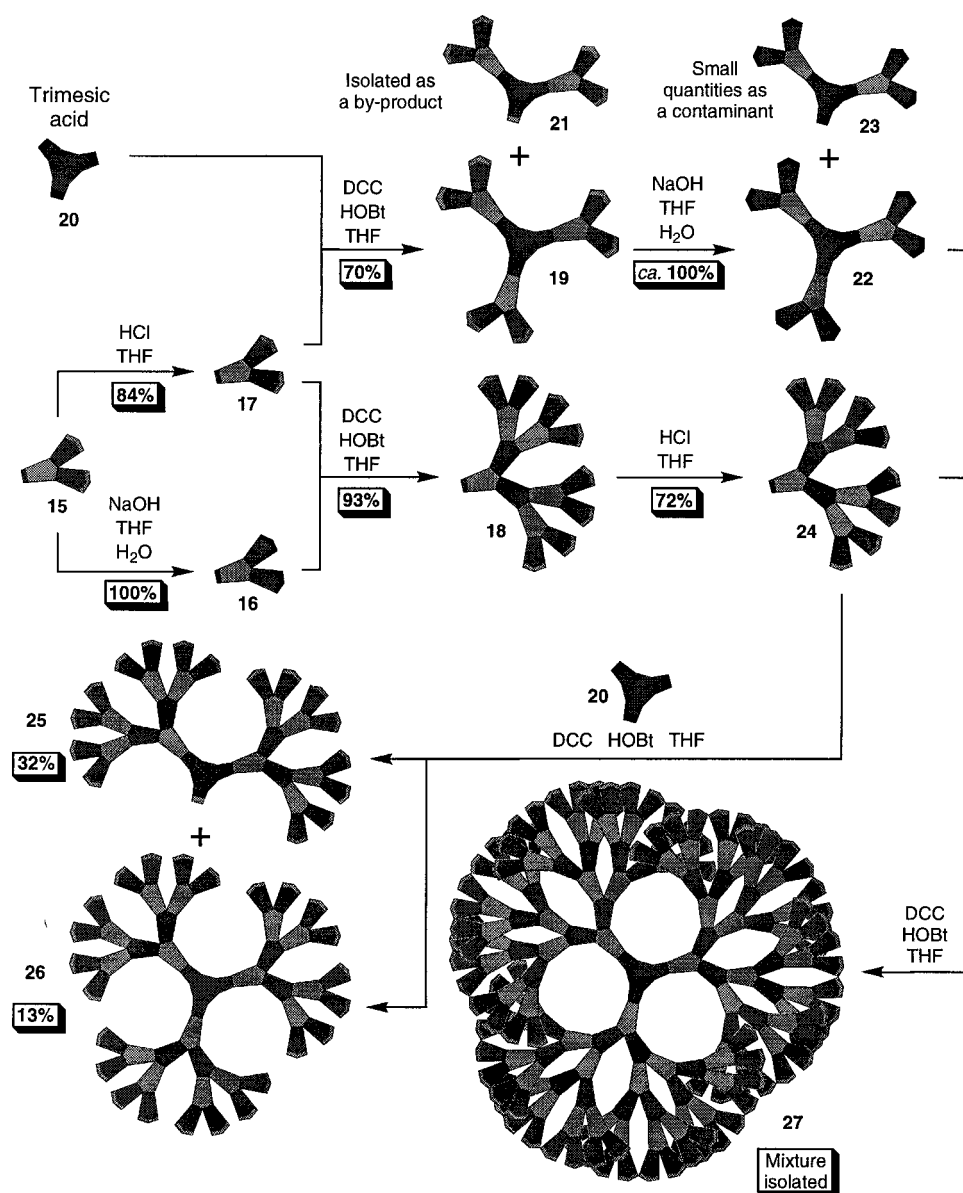

Scheme 7. Cartoon representation of the synthesis of dendrimers from the building block 15.

permeation chromatography (GPC). This technique was able to resolve a narrow peak corresponding to high molecular weight products. A measured amount of the reaction mixture was subjected to preparative GPC.<sup>[44]</sup> The high molecular weight peak was isolated and found to account for approximately 32% of the dendritic starting materials, indicating that, on average, reaction of about one-third of the 12 active sites on the core had occurred. Clearly, steric hindrance is of extreme importance in this reaction. This conclusion is consistent with the observation of a low yield in the formation of the fourth-generation dendrimer 26.

In order to complete the family of dendrimers, the one-directional analogues 29 and 30 of the second- and fourth-generation dendrimers 19 and 26 were formed (Scheme 8). The second- and fourth-generation wedges 17 and 24 were each coupled with benzoic acid (28), a one-directional version of the trimesic acid core that was used to make the three-directional dendrimers.

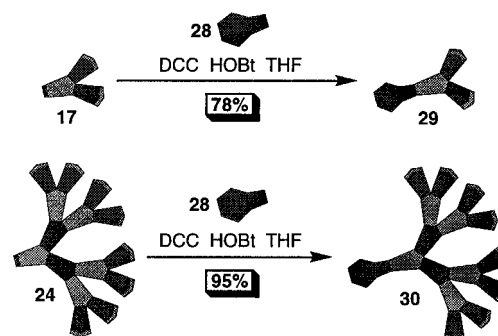

Scheme 8. Cartoon representation of the synthesis of one-directional dendrimers 29 and 30.

**Mass spectrometry:** The mass spectrometry (MS) of dendrimers is a much studied<sup>[45]</sup> subject. All the dendrimers in our series were studied by FABMS and MALDI-TOFMS. The peaks, which were obtained for pseudomolecular ions, are

Table 1. Molecular ions obtained for the second- and fourth-generation dendrimers and wedges observed by FABMS and MALDI-TOFMS.

	Wedges <sup>[a]</sup>		Dendrimers <sup>[b]</sup>		
	protected wedge	amine wedge	$N_c = 1$	$N_c = 2$	$N_c = 3$
Second generation	$626 = [M+H]^+$ (FAB)	$490 = [M+H]^+$ (FAB)	$594 = [M+H]^+$ (FAB)	$1167 = [M+H]^+$ (FAB)	$1624 = [M+H]^+$ (FAB)
Fourth generation	$2456 = [M+H]^+$ (FAB)	$2320 = [M+H]^+$ (FAB)	$2446 = [M+H]^+$ (FAB)	$4827 = [M+H]^+$ (FAB)	$7113 = [M+H]^+$ (FAB)
				$4848^{[c]}$ $4847^{[d]}$ (MALDI-TOF)	$7144^{[c]}$ $7146^{[d]}$ (MALDI-TOF)

[a] Protected wedge refers to the diethylphosphoramidate-protected wedges **15** and **18**. Amine wedge refers to the deprotected wedges **17** and **24**. [b]  $N_c$  denotes the core multiplicity of the dendrimer. [c] Performed with a gentisic acid matrix. [d] Performed with a retinoic acid matrix.

tabulated in Table 1. Although we were able to generate  $[M+H]^+$  ions for all the pure dendrimers by FABMS, the fourth-generation three-directional dendrimer **26** gave a peak of very low intensity, and the mixture of sixth-generation products showed no high molecular weight peaks at all.

MALDI-TOFMS was carried out on the two- and three-directional fourth-generation dendrimers. This technique is extremely sensitive to the matrix, and initial experiments with sinnapinic acid and indoleacrylic acid matrices were unsuccessful in affording any satisfactory results. A gentisic acid matrix revealed molecular ions for fourth-generation dendrimers, but strong spectra were only obtained with a retinoic acid matrix in which the dendrimers could be ionized with a relatively low laser power, leading to much less fragmentation and baseline noise than was observed for other matrices. Molecular ions obtained by MALDI-TOFMS were in the mass region expected for  $[M+Na]^+$  ions. Analysis of the mixture of sixth-generation products by MALDI-TOFMS was unsuccessful.

**Gel permeation chromatography:** GPC was carried out on the entire family of dendrimers in order to examine the structural changes that take place with varying generation and core directionality. Elution times were measured for:

- the two three-directional dendrimers **19** and **26**;
- the two two-directional dendrimers **21** and **25**, formed as by-products in the synthesis of **19** and **26**;
- the two one-directional dendrimers **29** and **30**;
- the high molecular weight material from the sixth-generation dendrimer-forming reaction;
- the zero-generation dendrimer analogue trimethyl trimethyl (31).

Comparison of the composite GP chromatograms A and B (Figure 3) sheds some interesting light on the relative structures of the dendrimers. Chromatogram A shows a series of second-generation dendrimers. It is clear that, in this instance, raising the directionality of the core lowers the elution time, demonstrating that molecules with higher directionalities (and thus higher masses) occupy greater volumes, as would be expected for linear polymers. This trend is not nearly so pronounced for the corresponding series of fourth-generation dendrimers (see chromatogram B). While the one-directional dendrimer is observed to be significantly smaller than either of its two- or three-directional derivatives, the latter have almost identical elution volumes. This result suggests that these molecules occupy almost the same volume despite the fact that the three-directional dendrimer has 1.5 times the mass of the two-directional derivative. Such an observation can be interpreted

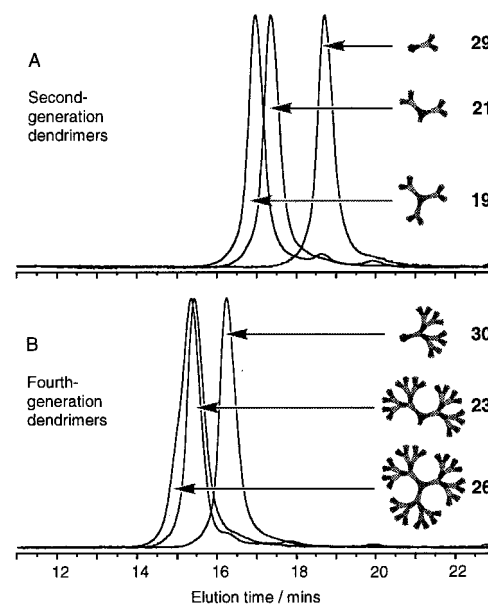

Figure 3. The composite chromatograms of: A) the second-generation dendrimers **19**, **21**, and **29**; B) the fourth-generation dendrimers **23**, **26**, and **30**.

as an intrinsic property of medium-to-high-generation dendrimers. As the dendrimer grows, the number of surface groups increases exponentially, eventually leading<sup>[46]</sup> to a globular, almost spherical shape. The diameter of this shape depends very largely on the length of the arms of the dendrimer from its core to the surface. In the case of the two- and three-directional fourth-generation dendrimers, this length is exactly the same. We are led to conclude that the fourth-generation dendrimer **26** is forced to adopt a highly globular conformation in solution. The second-generation dendrimer **19** does not have a greater surface area per surface group<sup>[47]</sup> than **26** and yet does not exhibit this unusual feature. The globular conformation of **26** is thus partly a result of its large number of end groups giving rise to a high probability of spherical topology, that is, the shape is entropy-driven rather than sterically driven as is the case with the spherical architecture of a dendrimer close to its dense-packing limit.

The composite GP chromatogram given in Figure 4 shows the series of three-directional dendrimers from generation zero to the mixture of sixth-generation products. While we can observe that increasing generation number leads to increasing size, we cannot gain quantitative knowledge from the data in this form. In order to correlate generation number with a practical quantity, the GPC column was calibrated with respect to the hydrodynamic radius of the analyte.<sup>[48]</sup> Figure 5 shows a graph of dendrimer generation against calculated

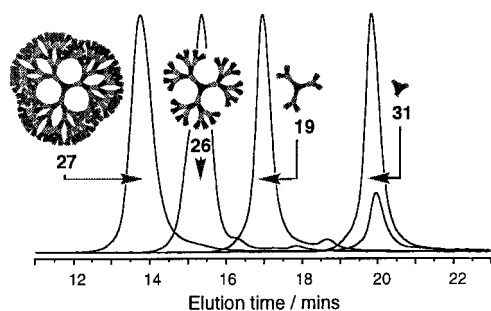

Figure 4. The composite chromatogram for the three-directional dendrimers **19**, **26**, **27**, and **31**. The small peak at 20 min is a consequence of the (butylated hydroxytoluene) stabilizer present in the GPC grade THF that was used in the purification of the sixth-generation product mixture.

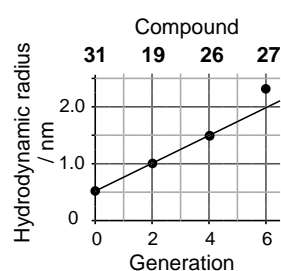

Figure 5. A plot of dendrimer generation against hydrodynamic radius for the three-directional dendrimers **19**, **26**, **27**, and **31**.

diameter. Although the distinctive linear relationship that is an accepted feature<sup>[18]</sup> of dendrimers is undeniably evident, there is a slight deviation observed for the sixth-generation mixture. This nonlinearity could be explained by the close packing of surface groups. As the generation number increases and surface congestion becomes important, we might expect that the internal

structures develop a much more extended conformation. The result would be a plot of generation against diameter which deviates from linearity at high values.

**NMR spectroscopy:** There is great interest in the internal structure and dynamics of dendritic systems, since these properties dictate many of their unusual characteristics. Although many probes of the dendritic microenvironment have been developed, and molecular dynamics simulations have also been utilized, NMR spectroscopy provides a good way of determining the internal dynamics of dendrimers. For instance,  $^{13}\text{C}$   $T_1$  relaxation times have been used<sup>[49]</sup> to gain insight into the mobility of different parts of dendrimers.

The  $^1\text{H}$  NMR chemical shift data for the second- and fourth-generation dendrimers are listed in Table 2. This

Table 2.  $^1\text{H}$  Chemical shift data for the second- and fourth-generation dendrimers **19**, **21**, **25**, **26**, **29**, and **30**.

$g^{[b]}$	$n_c^{[c]}$	$\text{NCH}_2$	$\delta$ at 373 K at 400 MHz in $\text{CD}_3\text{SOCD}_3^{[a]}$						
			aliphatic		inner <sup>[f]</sup> Ar		outer <sup>[f]</sup> Ar		
			$\text{CH}_2\text{O}$	2H	H	2H	H	Me	
<b>29</b>	2	1	4.06	4.40	–	–	7.63	8.10	3.90
<b>21</b>	2	2	3.88	4.31	–	–	7.53	7.97	3.85
<b>19</b>	2	3	3.91	4.29	–	–	7.49	7.92	3.84
<b>30</b>	4	1	3.85–3.9	4.28 <sup>[d]</sup> 4.24 <sup>[e]</sup>	7.06	7.20	7.50	7.94	3.83
<b>25</b>	4	2	3.8–3.9	4.2–4.3	7.09	7.21	7.45	7.88	3.80
<b>26</b>	4	3	3.90 <sup>[d]</sup> 3.83 <sup>[e]</sup>	4.30 <sup>[d]</sup> 4.20 <sup>[e]</sup>	7.10	7.23	7.40	7.83	3.77

[a] Resonances for protons of the core moieties have not been tabulated. [b]  $g$  represents the generation number of the dendrimer. [c]  $n_c$  represents the core multiplicity of the dendrimer. [d] Inner moiety. [e] Outer moiety. [f] Where the dendrimer has only one aromatic branching unit, this is considered to be the outer unit.

visualization of the data not only reveals how similar the spectra are, but also shows an interesting trend in chemical shifts for the  $^1\text{H}$  nuclei near the surface of the dendrimer. As the number of terminal groups increases (moving down the table), the signals for these surface protons resonate slightly further upfield. These shifts (0.1–0.3 ppm) are small, and may be the consequence of a microenvironmental effect. Similar upfield shifts of these resonances are observed as the dendrimers are warmed up. The internal moieties of the larger dendrimers do not exhibit this behavior. In fact, increasing the core directionality of the dendrimers causes a very slight downfield movement of the aromatic  $^1\text{H}$  nuclei. These trends are shown in graph form in Figure 6.

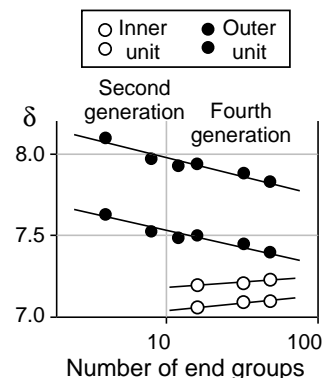

Figure 6. A plot showing the variation of chemical shift of aromatic  $^1\text{H}$  nuclei with the number of surface (methyl ester) groups on the dendrimer, on a logarithmic scale. The data is listed in Table 2.

The  $^1\text{H}$  NMR spectra for the one-, two-, and three-directional second-generation dendrimers **29**, **21**, and **19** appear to be very similar with the exception of the resonances for the aromatic core. Spectra for the three-directional dendrimer **19** in  $\text{CD}_3\text{SOCD}_3$  are shown in Figure 7. At

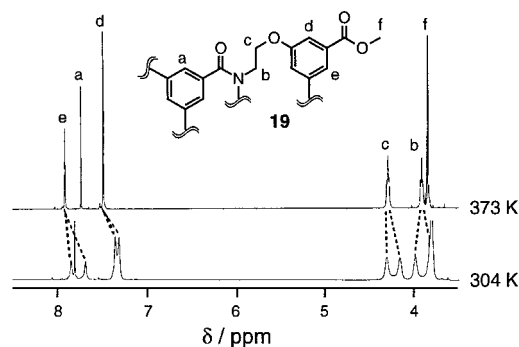

Figure 7. The  $^1\text{H}$  NMR spectra of the three-directional second-generation dendrimer **19** at 304 and 373 K recorded in  $\text{CD}_3\text{SOCD}_3$  at 400 MHz.

297 K, apart from the core and surface protons, every signal appears as two broad peaks, a consequence of the slow rotation of amide bonds on the  $^1\text{H}$  NMR timescale. When the temperature is raised to 397 K, these broad signals collapse into  $\text{A}_2\text{B}_2$  and  $\text{AB}_2$  systems for aliphatic and aromatic protons, respectively, in line with amide bond rotation becoming fast on the  $^1\text{H}$  NMR timescale. Energy barriers for these degenerate processes were calculated<sup>[50]</sup> (Table 3) at the



Table 3. Kinetic and thermodynamic parameters for amide bond rotations of the one-, two-, and three-directional second-generation dendrimers **29**, **21**, and **19** in CD<sub>3</sub>SOCD<sub>3</sub> and at 400 MHz determined by variable-temperature <sup>1</sup>H NMR spectroscopy by the coalescence method (see ref. [23]).

	Probe protons <sup>[b]</sup>	$\Delta\bar{\nu}$ (Hz)	$k_c$ (s <sup>-1</sup> )	$T_c$ (K)	$\Delta G^\ddagger$ (kcal mol <sup>-1</sup> )
<b>29</b> ( $n_c=1$ ) <sup>[a]</sup>	NCH <sub>2</sub> {b}	78.8	175	318	15.4
<b>29</b> ( $n_c=1$ )	CH <sub>2</sub> O {c}	45.2	100	313	15.5
<b>21</b> ( $n_c=2$ )	Ar (2H) {d}	8.0	18	304	16.1
<b>21</b> ( $n_c=2$ )	Ar (H) {e}	36.4	81	315	15.7
<b>19</b> ( $n_c=3$ )	Ar (2H) {d}	16.4	36	313	16.1
<b>19</b> ( $n_c=3$ )	Ar (H) {e}	64.0	142	324	15.8

[a]  $n_c$  refers to the core multiplicity of the dendrimer. [b] The letter in curly brackets refers to the analogous proton of **19**, depicted in Figure 7.

coalescence temperatures for the aromatic protons, measured by variable-temperature (VT) NMR spectroscopy. In the case of the one-directional dendrimer **29**, the coalescence temperature of the aromatic proton resonances was too close to the freezing point of the solvent to be accessible and so the coalescences of the aliphatic resonances were measured. Although there appears to be a slight increase in the free energy of activation for the amide bond rotation process as the dendrimer acquires more directionality, the results for the three dendrimers lie within experimental error of each other. In essence, we are unable to suggest that the three-directional dendrimer **19** is significantly more rigid than the one-directional dendrimer **29**. This result is consistent with the GPC finding that the second-generation dendrimer series behave much like linear polymers.

The two-directional fourth-generation dendrimer **25** is the largest dendrimer we have prepared in sufficient purity for VT-NMR spectroscopic analysis. The aromatic regions of <sup>1</sup>H NMR spectra, recorded at various temperatures, are shown in Figure 8. At 292 K, the resonances for the protons of the inner

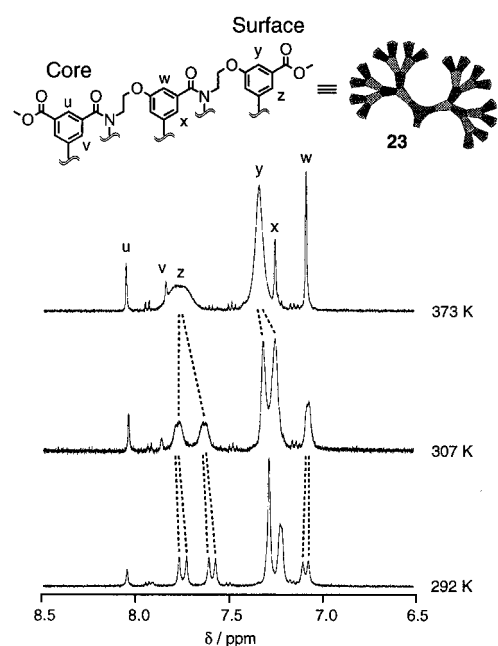

Figure 8. The <sup>1</sup>H NMR spectra of the two-directional fourth-generation dendrimer **23** at 292, 307, and 373 K recorded in CD<sub>3</sub>SOCD<sub>3</sub> at 400 MHz.

building blocks are separated into two signals as a consequence of the hindered rotation about the inner amide bonds. The signals for protons in the outer building blocks, however, can be affected by both the inner and the outer amide bonds, leading to the observed four signals for proton **z**. As the sample is warmed up, pairs of the four signals coalesce, leaving two peaks at 306 K. If the process we are observing emanates from the inner amide bond, then the two coalescences describe the same process, and will have the same energy. However, if this process is a consequence of the outer amide bonds, then the two coalescences describe different processes, and may exhibit different energy barriers. When the sample is warmed up further, the peaks finally collapse into a single peak, as all the amide bond rotations become fast on the <sup>1</sup>H NMR timescale. Free energies of activation for the processes described above were calculated from VT-NMR coalescence studies on the dendrimer. The  $\Delta G^\ddagger$  values are presented in Table 4. We might expect that the smaller

Table 4. Kinetic and thermodynamic parameters for amide bond rotations of the 2-directional second-generation dendrimer **25** in CD<sub>3</sub>SOCD<sub>3</sub> and at 400 MHz as determined by the NMR coalescence method.

Process <sup>[a]</sup>	Probe protons <sup>[b]</sup>	$\Delta\bar{\nu}$ (Hz)	$k_c$ (s <sup>-1</sup> )	$T_c$ (K)	$\Delta G^\ddagger$ (kcal mol <sup>-1</sup> )
outer	<b>y</b> <sup>[c,d]</sup>	25.2	56	321	16.3
outer	<b>z</b> <sup>[c]</sup>	56	124	326	16.0
inner	<b>w</b>	11.6	26	307	16.0
inner	<b>z</b> <sup>[c]</sup>	14.8	33	307	15.8
inner	<b>z</b> <sup>[c]</sup>	16.0	36	307	15.8

[a] Inner refers to the rotation of the amide bond closer to the core, whilst outer refers to the rotation of the amide bond closer to the surface. [b] The protons **w**, **x**, **y**, **z** are defined in Figure 8. The resonance for proton **x** is obscured. [c] Inner and outer assignments are tentative. [d] Proton **y** cannot be used to measure other processes under these conditions as a temperature below the freezing point of the solvent is required.

separations (two signals into four) of the protons **z** reflect hindered rotation about the more distant inner amide bonds. The results of the coalescence studies are consistent with this hypothesis—the two coalescences describe a process with *the same free energy of activation*. Comparisons of these results with those from the analyses of the second-generation dendrimers can be made (Figure 8). The outer amide bond rotations probed by protons **y** and **z** in the fourth-generation dendrimer are associated with slightly higher energy barriers than the analogous processes (probed by protons **d** and **e**) in the second-generation dendrimers. This observation suggests that the larger dendrimer is more sterically crowded on the surface of the molecule. Indeed, this conclusion has already been reached on the basis of GPC analyses and comparisons of yields.

**Molecular modeling:** Molecular modeling studies have been used extensively in the analysis and visualization of dendrimers.<sup>[51]</sup> Of particular interest are their shapes and diameters, the existence of voids and channels, and the positions of the chain ends. These topological features are likely to dictate the properties, unique to dendrimers, that we wish to exploit. Molecular dynamics simulations were conducted<sup>[52]</sup> on the

dendrimers **19**, **26**, and **27**, utilizing the AMBER\* forcefield resident within the Macromodel<sup>[53]</sup> package. Figure 9 shows structures of the second-generation three-directional dendrimer **19**, taken from a stochastic molecular dynamics run

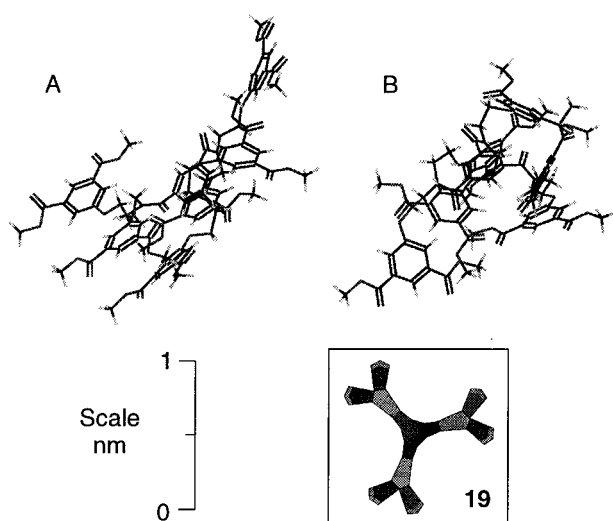

Figure 9. Two room-temperature samples (A and B) of conformations available to the three-directional second-generation dendrimer **19** at 300 K as determined by stochastic molecular dynamics.

after equilibration at 300 K. A high degree of conformational freedom is evident, reiterating the similarity observed between this dendrimer and a linear polymer. The models measure an average of 1.1 nm in radius, in very close agreement with the results (radius of 1.0 nm) of the GPC analysis. The structure of the fourth-generation three-directional dendrimer **26** (Figure 10) is strikingly different. Much

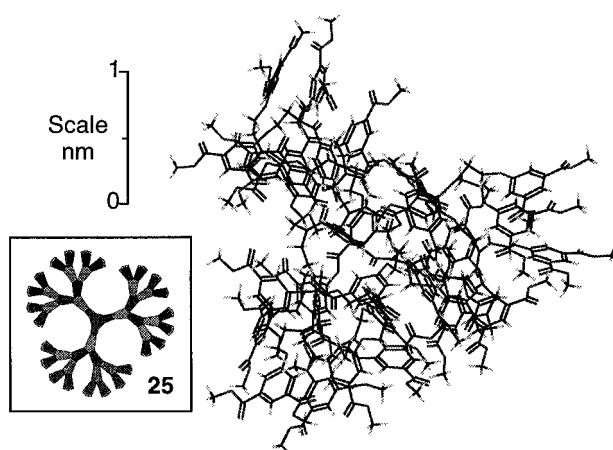

Figure 10. A possible conformation of the fourth-generation dendrimer **25** at 300 K as determined by stochastic molecular dynamics.

less conformational freedom is observed, and a more globular structure results from the steric congestion of surface groups. The model has an average radius of 1.6 nm, which is once again consistent with the GPC analysis where a radius of 1.5 nm was deduced.

Finally, a structure for the sixth-generation three-directional dendrimer **27** is shown in Figure 11. Analysis of the energetics of this structure reveals that none of the energy

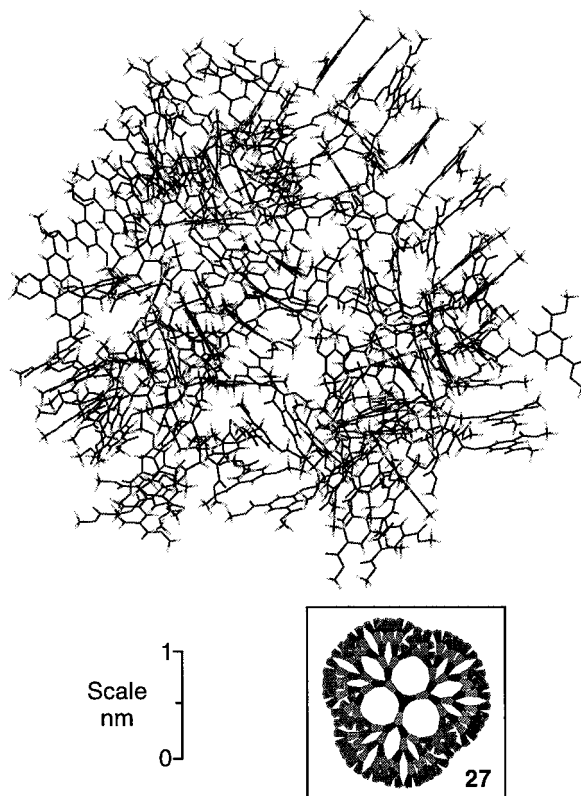

Figure 11. One transient conformation of the sixth-generation dendrimer **27** at 300 K as determined by stochastic molecular dynamics.

terms are unrealistically high, suggesting that the structure is certainly a feasible synthetic target. This is not surprising, since the theoretical volume available to monomer units in the sixth-generation dendrimer is little different from that in the second-generation dendrimer **19**.<sup>[54]</sup> All of the observed conformations at 300 K are highly globular, and channels and voids are apparent in the structure. As with the fourth-generation dendrimer, the chain ends reside predominantly at the surface of the molecule, and once again, the radius of the model (2.4 nm) compares remarkably well with the value obtained experimentally (2.3 nm) from GPC of the sixth-generation product mixture.

## Conclusions

The construction of a family of dendrimers derived from diethanolamine and 5-hydroxyisophthalic acid branching units has been accomplished. The family consists of one-, two-, and three-directional second- and fourth-generation dendrimers (the zero-generation analogue) and a mixture of sixth-generation dendritic products. These dendrimers have been synthesized from a second-generation building block in the form of an orthogonally protected amino tetraacid. We believe that the simplicity and versatility of this dendritic

building block gives us the potential to incorporate other units within the dendritic structure at will; any suitably protected amino polyacid could be used as a monomer in any convergent or divergent generation-adding step.

The internal structure of the dendrimers has been probed by GPC, VT-NMR spectroscopy and molecular modeling experiments. The results of these studies are highly consistent with each other. They show that the higher generation dendrimers adopt the globular, void-containing conformations associated with the properties that are peculiar to dendrimers. This observation is particularly interesting considering that these higher generation dendrimers are not close to their starburst limit. We are led to the conclusion that these structures and their analogues could harbor the potential to act as host molecules and exhibit other novel properties. However, caution must be exercised when elevating dendritic structures to supramolecular status. The dendritic structure is a dynamic system, and, as such, lacks the degree of preorganization that is necessary for highly specific interactions with substrates.

## Experimental Section

**General procedures and instrumentation:** Chemicals were purchased from Aldrich and were used without further purification. Solvents were dried according to literature methods. Column chromatography was performed on silica gel 60 (particle size 0.040–0.063 mm, Merck 9385) and thin-layer chromatography (TLC) on Merck aluminum-backed plates coated with silica gel 60 F<sub>254</sub> (layer thickness 0.2 mm). Once eluted, plates were dried with hot air and scrutinized under a UV lamp or developed using a ninhydrin<sup>[55]</sup> or cerium<sup>[56]</sup> stain. High performance liquid chromatography (HPLC) was performed on a Phenomenex IB-Sil C-18 column (250 × 10 mm), eluted on Gilson 305 and 306 HPLC pumps. The pumps were controlled by external Gilson 715 software running on a 486 PC; detection was achieved with a Dynamax UV-1 ultraviolet detector set at 254 nm. GPC was carried out on two 300 mm Phenomenex Phenogel styrene/divinylbenzene columns with pore sizes of 500 and 50 Å. The columns were linked in series and were calibrated with polystyrene standards purchased from Polymer Laboratories Limited. The columns were eluted with pure GPC grade THF (stabilized with BHT) on the HPLC system. Melting points were determined on an Electrothermal 9200 melting point apparatus and are uncorrected. Routine NMR spectra were recorded on a Bruker AC300 (300 MHz for <sup>1</sup>H, 75 MHz for <sup>13</sup>C) spectrometer. Variable-temperature spectra were obtained on a Bruker AMX400 (400 MHz for <sup>1</sup>H, 100 MHz for <sup>13</sup>C) spectrometer. With both spectrometers, the solvent reference was used as internal standard. Electron impact–chemical ionization mass spectrometry (EI-CIMS) was carried out on a Kratos Profile mass spectrometer and liquid secondary ion mass spectrometry (LSIMS) on a VG ZabSpec instrument, equipped with a cesium ion source and using 3-nitrobenzyl alcohol as the matrix. Matrix-assisted laser desorption–ionization (time of flight) mass spectrometry (MALDI-TOFMS) was performed on a Kratos Kompact instrument with either gentisic acid (2,5-dihydroxybenzoic acid), sinnapinic acid (3,5-dimethoxy-4-hydroxycinnamic acid),  $\beta$ -*l*-indoleacrylic acid, or *all trans*-retinoic acid as the matrix, and was calibrated with insulin. Microanalyses were performed by either the University of Birmingham Microanalytical Service, the University of Sheffield Microanalytical Service, or the University of North London Microanalytical Service.

***N,N*-Bis[2-(*p*-toluenesulfonyloxy)ethyl]-*p*-toluenesulfonamide (3):** Dry Et<sub>3</sub>N (80 mL), diethanolamine (**1**, 10.0 g, 95 mmol), and a catalytic quantity of DMAP were dissolved in dry CH<sub>2</sub>Cl<sub>2</sub> (400 mL) in a 1 L flask. The solution was cooled to 0 °C, then *p*-toluenesulfonyl chloride (65.1 g, 341 mmol) in dry CH<sub>2</sub>Cl<sub>2</sub> (100 mL) was added slowly through a pressure-equalized dropping funnel, while the temperature was maintained below 5 °C with constant stirring. The reaction mixture was allowed to

reach ambient temperature, and was then stirred overnight. The reaction mixture was poured onto ice (50 g) and then neutralized by the addition of concentrated HCl. The organic layer was added to extractions (CH<sub>2</sub>Cl<sub>2</sub>, 2 × 50 mL) of the aqueous layer, before being dried (CaCl<sub>2</sub>). The solvent was removed in vacuo to give a solid which was recrystallized twice from MeOH to give the sulfonamide **3** (45.8 g, 85 %), white solid, m.p. 95–96 °C. <sup>1</sup>H NMR (300 MHz, CDCl<sub>3</sub>, 25 °C):  $\delta$  = 7.76 (m, 4H; Ar), 7.62 (m, 2H; Ar), 7.37 (m, 4H; Ar), 7.30 (m, 2H; Ar), 4.11 (t,  $J$  = 6 Hz, 4H; CH<sub>2</sub>O), 3.37 (t,  $J$  = 6 Hz, 4H; NCH<sub>2</sub>), 2.47 (s, 6H; CH<sub>3</sub>), 2.43 (s, 3H; CH<sub>3</sub>); <sup>13</sup>C NMR (75 MHz, CDCl<sub>3</sub>, 25 °C):  $\delta$  = 145, 144, 135, 132, 130, 128, 127, 68, 48, 21; MS (CI +):  $m/z$  (%) = 585 (11%) [M+NH<sub>4</sub>]<sup>+</sup>, 567 (1%) [M]<sup>+</sup>, 242 (100%) [M–2OTs+H]<sup>+</sup>; C<sub>25</sub>H<sub>29</sub>NO<sub>8</sub>S<sub>3</sub>; calcd C 52.89, H 5.15, N 2.47; found C 53.19, H 5.14, N 2.36.

**Diethyl 5-hydroxyisophthalate (4):** 5-Hydroxyisophthalic acid (**2**, 23.5 g, 129 mmol) was dissolved in EtOH (400 mL), and concentrated H<sub>2</sub>SO<sub>4</sub> was added (20 mL). The reaction mixture was stirred under reflux for 5 d. After cooling, saturated NaHCO<sub>3</sub> solution (ca. 400 mL) was added carefully to neutralize the acid. The solution was reduced in volume to ca. 400 mL in vacuo, more H<sub>2</sub>O (200 mL) was added, and the product was obtained by filtration, before being washed with H<sub>2</sub>O (50 mL) to give the diester **4** (26.3 g, 86 %) as a colorless solid, m.p. 105–106 °C. <sup>1</sup>H NMR (300 MHz, CD<sub>3</sub>COCD<sub>3</sub>, 25 °C):  $\delta$  = 9.06 (s, 1H; OH), 8.12 (t,  $J$  = 1.5 Hz, 1H; Ar), 7.70 (d,  $J$  = 1.5 Hz, 2H; Ar), 4.37 (q,  $J$  = 7 Hz, 4H; CH<sub>2</sub>), 1.38 (t,  $J$  = 7 Hz, 6H; CH<sub>3</sub>); <sup>13</sup>C NMR (75 MHz, CD<sub>3</sub>COCD<sub>3</sub>, 25 °C):  $\delta$  = 165.9, 158.7, 133.0, 121.8, 121.0, 61.7, 14.4; MS (CI +):  $m/z$  (%) = 239 (90%) [M+H]<sup>+</sup>, 256 (100%) [M+NH<sub>4</sub>]<sup>+</sup>; C<sub>12</sub>H<sub>14</sub>O<sub>5</sub>; calcd C 60.50, H 5.92; found C 60.76, H 5.97.

***N,N*-Bis[2-[3,5-bis(ethoxycarbonyl)phenoxy]ethyl]-*p*-toluene sulfonamide (5):** A suspension of K<sub>2</sub>CO<sub>3</sub> (38 g, 275 mmol) in MeCN (1500 mL) was degassed. The sulfonamide **3** (18.3 g, 32.3 mmol) and the diester **4** (26.7 g, 112 mmol) were dissolved in the solvent, and the reaction mixture was then stirred under reflux for 7 d. The reaction mixture was cooled down, filtered at the pump, and the solid was washed with MeCN (ca. 50 mL). The solvent was removed in vacuo to leave a thick yellow syrup, which crystallized from MeOH/H<sub>2</sub>O to give the pure sulfonamide **5** (18.7 g, 83 %) as a white solid, m.p. 66 °C. <sup>1</sup>H NMR (300 MHz, CDCl<sub>3</sub>, 25 °C):  $\delta$  = 8.26 (t,  $J$  = 1.5 Hz, 2H; Ar), 7.75 (m, 2H; Ar), 7.62 (d,  $J$  = 1.5 Hz, 4H; Ar), 7.26 (obscured by solvent, m, Ar), 4.39 (q,  $J$  = 7 Hz, 8H; CO<sub>2</sub>CH<sub>2</sub>), 4.27 (t,  $J$  = 6 Hz, 4H; CH<sub>2</sub>O), 3.75 (t,  $J$  = 6 Hz, 4H; NCH<sub>2</sub>), 2.38 (s, 3H; CH<sub>3</sub>), 1.39 (t,  $J$  = 7 Hz, 12H; CH<sub>3</sub>); <sup>13</sup>C NMR (75 MHz, CDCl<sub>3</sub>, 25 °C):  $\delta$  = 165.5, 158.2, 143.8, 136.6, 132.2, 129.8, 127.2, 123.4, 119.5, 67.6, 61.4, 48.7, 21.5, 14.3; MS (EIMS +):  $m/z$  (%) = 700 (16%) [M+H]<sup>+</sup>, 654 (100%) [M–OEt]<sup>+</sup>; C<sub>35</sub>H<sub>41</sub>NO<sub>10</sub>S; calcd C 60.07, H 5.74, N 2.00; found C 59.97, H 5.74, N 2.07.

**Bis[2-[3,5-bis(hydroxymethyl)phenoxy]ethyl]amine (6):** Red-Al (65 % in PhMe, 7 mL) was added to dry dioxane (100 mL) with vigorous stirring under nitrogen. A solution of sulfonamide **5** (0.89 g, 1.27 mmol) in dry dioxane (50 mL) was added dropwise over a period of 30 min using a pressure-equalized dropping funnel. The bright yellow reaction mixture was brought to reflux. The color changed to green and then to reddish-orange. The reaction mixture was then heated under reflux for 18 h, after which time the mixture resembled mud. On cooling, the excess of reagent was decomposed by the dropwise addition of 10 % aqueous NaOH solution (15 mL). This mixture was stirred for 30 min before the solvents were removed in vacuo. The residue was dissolved in H<sub>2</sub>O (50 mL) and the aqueous solution was extracted with EtOAc (5 × 50 mL). These extracts were combined, dried (Na<sub>2</sub>SO<sub>4</sub>), filtered, and the solvent was removed in vacuo to leave a thick yellow syrup. This crude product was purified by column chromatography on silica gel, eluting with a solvent gradient from pure EtOAc to 6:3:1 EtOAc:Et<sub>3</sub>N:MeOH to give the amine **6** (68 mg, 14 %) as a thick colorless syrup. <sup>1</sup>H NMR (300 MHz, CD<sub>3</sub>COCD<sub>3</sub>, 25 °C):  $\delta$  = 6.90 (s, 2H; Ar), 6.83 (s, 4H; Ar), 4.56 (s, 8H CH<sub>2</sub>OH), 4.07 (t,  $J$  = 6 Hz, 4H; CH<sub>2</sub>OAr), 3.5 (br, 4H; OH), 3.02 (t,  $J$  = 6 Hz, 4H; NCH<sub>2</sub>); <sup>13</sup>C NMR (75 MHz, CD<sub>3</sub>COCD<sub>3</sub>, 25 °C):  $\delta$  = 160.0, 144.7, 117.7, 111.9, 68.4, 64.4, 49.3; MS (EI +):  $m/z$  (%) = 210 (84%) [M–CH<sub>2</sub>OC<sub>6</sub>H<sub>3</sub>(CH<sub>2</sub>OH)<sub>2</sub>]<sup>+</sup>.

***N,N*-Bis[2-(4-toluene)sulfonyloxy]ethyl(diethyl)phosphoramidate (7):** Diethanolamine (**1**, 25.4 g, 242 mmol) was added to a stirred mixture of KHCO<sub>3</sub> (49.5 g, 495 mmol), K<sub>2</sub>CO<sub>3</sub> (70.4 g, 510 mmol) and TBAB (4.32 g, 12 mmol) in THF (250 mL). The mixture was cooled to 5 °C under a nitrogen atmosphere, after which a solution of diethylphosphite (36.3 g, 265 mmol) in CCl<sub>4</sub> (50 mL) was added dropwise. The reaction mixture was allowed to reach ambient temperature and then stirred for a further 1 h. The mixture was filtered and the filtrate was combined with a washing of

the solid with  $\text{CH}_2\text{Cl}_2$  (50 mL). Finally, the solvents were removed in vacuo. The remaining thick oil (64.7 g) was dissolved in  $\text{CH}_2\text{Cl}_2$  (200 mL);  $\text{C}_5\text{H}_5\text{N}$  (45 mL) and a catalytic quantity of DMAP were added. The reaction mixture was cooled to  $0^\circ\text{C}$ , while stirring was maintained under a nitrogen atmosphere. A solution of *p*-toluenesulfonyl chloride (106.7 g, 562 mmol) in  $\text{CH}_2\text{Cl}_2$  (200 mL) was added carefully without allowing the temperature to exceed  $0^\circ\text{C}$ . Then, the reaction mixture was allowed to warm up while it was stirred for a further 4 h.  $\text{H}_2\text{O}$  (150 mL) was added and the reaction was stirred vigorously for a further 30 min, before more  $\text{H}_2\text{O}$  (150 mL) was added. The organic layer was combined with one extraction (50 mL) of the aqueous phase with  $\text{CH}_2\text{Cl}_2$ . The crude material was recovered by evaporation of the organic solvents after the solution had been dried ( $\text{CaCl}_2$ ). The pure product was easily obtained by flash column chromatography on a short silica gel column, eluting with a gradient from pure  $\text{CH}_2\text{Cl}_2$  to pure EtOAc to give the phosphoramidate **7** (55.3 g, 42%) as a thick colorless oil.  $^1\text{H}$  NMR (300 MHz,  $\text{CDCl}_3$ ,  $25^\circ\text{C}$ ):  $\delta$  = 7.76 (d,  $J$  = 8.1 Hz, 4H; Ar), 7.34 (d,  $J$  = 8.1 Hz, 4H; Ar), 4.04 (t,  $J$  = 5.5 Hz, 4H;  $\text{CH}_2\text{OTs}$ ), 3.9 (m, 4H;  $\text{CH}_2\text{OP}$ ), 3.27 (m, 4H;  $\text{NCH}_2$ ), 2.43 (s, 6H;  $\text{ArCH}_3$ ), 1.21 (dt,  $J$  = 0.95, 7.1 Hz, 6H;  $\text{CH}_3$ );  $^{13}\text{C}$  NMR (75 MHz,  $\text{CDCl}_3$ ,  $25^\circ\text{C}$ ):  $\delta$  = 145.0, 132.6, 129.9, 127.9, 68.8, 62.5 (d,  $J$  = 5.6 Hz), 46.2 (d,  $J$  = 4.5 Hz), 21.6, 16.0 (d,  $J$  = 7.3 Hz);  $^{31}\text{P}$  NMR (162 MHz,  $\text{CDCl}_3$ ,  $25^\circ\text{C}$ ):  $\delta$  = 9.20; MS (FAB+):  $m/z$  (%) = 378 (88) [ $M$  - OTs] $^+$ , 550 (100) [ $M$ +H] $^+$ ;  $\text{C}_{22}\text{H}_{32}\text{NO}_9\text{P}_2$ ; calcd C 48.08, H 5.87, N 2.55; found C 47.60, H 6.07, N 2.60.

**Dimethyl 5-hydroxyisophthalate (8)**: 5-Hydroxyisophthalic acid (**2**, 120 g, 659 mmol) and  $\text{H}_2\text{SO}_4$  (60 mL) were dissolved in MeOH (1000 mL) and the solution was stirred under reflux for 20 h. The reaction mixture was allowed to cool down to ambient temperature and then  $\text{H}_2\text{O}$  (1000 mL) was added. The product was isolated by filtration from the crude reaction mixture. It was then washed with  $\text{H}_2\text{O}$  (100 mL) to give the ester **8** (135 g, 97%) as a colorless solid, m.p.  $165^\circ\text{C}$ .  $^1\text{H}$  NMR (300 MHz,  $\text{CD}_3\text{COCD}_3$ ,  $25^\circ\text{C}$ ):  $\delta$  = 9.10 (br, 1H; OH), 8.11 (t,  $J$  = 1 Hz, 1H; Ar), 7.68 (d,  $J$  = 1 Hz, 2H, Ar), 3.91 (s, 6H;  $\text{CH}_3$ );  $^{13}\text{C}$  NMR (75 MHz,  $\text{CD}_3\text{COCD}_3$ ,  $25^\circ\text{C}$ ):  $\delta$  = 166.27, 158.48, 132.84, 122.05, 121.00, 52.48; MS (EI+):  $m/z$  (%) = 210 (36) [ $M$ ] $^+$ .

**3,5-Bishydroxymethylphenol (9)**: A solution of dimethyl 5-hydroxyisophthalate (**8**, 30.0 g, 143 mmol) in dry THF (150 mL) was added slowly under nitrogen to a stirred suspension of  $\text{LiAlH}_4$  (10.0 g, 263 mmol) in THF (500 mL). The reaction was stirred under reflux for 3 h before being left to cool down. The mixture was acidified by the addition of 10%  $\text{H}_2\text{SO}_4$  (200 mL) and then the THF was removed by distillation in vacuo. The resulting solution was extracted with EtOAc ( $5 \times 250$  mL) and the extracts were combined and dried ( $\text{MgSO}_4$ ). Filtration and evaporation of the solvent gave the pure phenol **9** (22.2 g, 100%) as a colorless solid, m.p.  $73$ – $74^\circ\text{C}$ .  $^1\text{H}$  NMR (300 MHz,  $\text{CD}_3\text{COCD}_3$ ,  $25^\circ\text{C}$ ):  $\delta$  = 8.17 (s, 1H; ArOH), 6.81 (s, 1H; Ar), 6.74 (s, 2H; Ar), 4.55 (d,  $J$  = 5 Hz, 4H;  $\text{CH}_2$ ), 4.10 (t,  $J$  = 5 Hz, 2H; OH);  $^{13}\text{C}$  NMR (75 MHz,  $\text{CD}_3\text{COCD}_3$ ,  $25^\circ\text{C}$ ):  $\delta$  = 158.2, 144.7, 116.5, 112.6, 64.6; MS (CI+):  $m/z$  (%) = 154 (100%) [ $M$ ] $^+$ ;  $\text{C}_8\text{H}_{10}\text{O}_3$ ; calcd C 62.34, H 6.49; found C 62.32, H 6.69.

**3,5-Bis(acetoxymethyl)acetoxymethylbenzene (10)**:  $\text{Ac}_2\text{O}$  (250 mL) was added with stirring to the phenol **9** (22.0 g, 142 mmol) in dry  $\text{C}_5\text{H}_5\text{N}$  (1000 mL) under nitrogen. The reaction mixture was stirred at ambient temperature for 24 h and then the solvents were removed in vacuo. The residue was dissolved in EtOAc (100 mL) and purified by filtration through silica, which was washed with further EtOAc (100 mL). The EtOAc was removed to give the pure triacetate **10** (38.0 g, 95%) as a thick colorless oil, b.p.  $115^\circ\text{C}$  (0.01 mbar, decomp.).  $^1\text{H}$  NMR (300 MHz,  $\text{CDCl}_3$ ,  $25^\circ\text{C}$ ):  $\delta$  = 7.16 (brs, 1H; Ar), 7.00 (brs, 2H; Ar), 5.04 (s, 4H;  $\text{CH}_2$ ), 2.24 (s, 3H;  $\text{CH}_3$ ), 2.06 (s, 6H;  $\text{CH}_3$ );  $^{13}\text{C}$  NMR (75 MHz,  $\text{CDCl}_3$ ,  $25^\circ\text{C}$ ):  $\delta$  = 170.2, 169.2, 150.6, 138.2, 124.6, 120.8, 64.7, 20.9, 20.7; MS (CI+):  $m/z$  (%) = 298 (43%) [ $M$ + $\text{NH}_4$ ] $^+$ ;  $\text{C}_{14}\text{H}_{16}\text{O}_6$ ; calcd C 60.00, H 5.75; found C 59.66, H 6.00.

***N,N*-Bis[2-(3,5-bisacetoxymethyl)phenoxy]ethyl(diethyl)phosphoramidate (11)**: The triacetate **10** (2.92 g, 104 mmol), 18-crown-6 (315 mg, 1.2 mmol),  $\text{K}_2\text{CO}_3$  (5.15 g, 37.3 mmol), and MeCN (dry, 50 mL) were placed in a flask under nitrogen and the reaction mixture was sonicated for 5 min. The mixture was stirred under reflux for 1 h before it was allowed to cool down to ambient temperature, at which point a solution of the phosphoramidate **7** (1.69 g, 3.8 mmol) in MeCN (dry, 10 mL) was added through a pressure-equalized dropping funnel. The reaction mixture was reheated and stirred under reflux for 2 d. After cooling, the mixture was filtered and the solid washed with MeCN (10 mL). The solvent was removed to leave a crude product, which was subjected to column chromatography on silica gel, eluting with EtOAc to give the phosphoramidate **11** (517 mg, 23%) as a thick

colorless oil.  $^1\text{H}$  NMR (300 MHz,  $\text{CD}_3\text{COCD}_3$ ,  $25^\circ\text{C}$ ):  $\delta$  = 7.00 (s, 2H; Ar), 6.93 (s, 4H; Ar), 5.06 (s, 8H;  $\text{PhCH}_2\text{O}$ ), 4.21 (t,  $J$  = 6 Hz, 4H;  $\text{CH}_2\text{O}$ ), 4.05 (m, 4H;  $\text{CH}_2\text{OP}$ ), 3.57 (m, 4H;  $\text{NCH}_2$ ), 2.06 (s, 12H;  $\text{COCH}_3$ ), 1.28 (t,  $J$  = 7 Hz, 6H;  $\text{CH}_3$ );  $^{13}\text{C}$  NMR (75 MHz,  $\text{CD}_3\text{COCD}_3$ ,  $25^\circ\text{C}$ ):  $\delta$  = 170.7, 159.9, 139.2, 120.5, 114.3, 67.8, 66.0, 62.5, 62.4, 47.3, 20.7, 16.5, 16.4;  $^{31}\text{P}$  NMR (162 MHz,  $\text{CDCl}_3$ ,  $25^\circ\text{C}$ ):  $\delta$  = 10.25; MS (FAB+):  $m/z$  (%) = 682 (100%) [ $M$ +H] $^+$ ;  $\text{C}_{32}\text{H}_{44}\text{NO}_{13}\text{P}$ ; calcd C 56.38, H 6.51, N 2.05; found C 56.33, H 6.64, N 2.13.

**Bis[2-(3,5-bisacetoxymethyl)phenoxy]ethylamine (12)**: A solution of the phosphoramidate **11** (2.01 g, 2.95 mmol) in freshly distilled THF (50 mL) was cooled to  $<5^\circ\text{C}$  before it was saturated with anhydrous HCl. The reaction mixture was allowed to warm up to ambient temperature and the reaction was followed by TLC until the starting material had almost completely disappeared (ca. 2 h). The volatiles were removed in vacuo and then the residue was shaken with  $\text{Et}_2\text{O}$  (50 mL). After decanting the liquid, the remaining material was dissolved in  $\text{H}_2\text{O}$  (50 mL) before being basified with 15% NaOH solution (2.5 mL). The mixture was extracted with  $\text{CH}_2\text{Cl}_2$  ( $2 \times 15$  mL) and the extractions were combined, dried ( $\text{MgSO}_4$ ), and concentrated to a residue. This crude product was purified by column chromatography on silica gel, eluting with a gradient from EtOAc:MeOH (9:1) to EtOAc: $\text{Et}_3\text{N}$ :MeOH (8:1:1) to give the amine **12** (498 mg, 31%) as a thick oil.  $^1\text{H}$  NMR (300 MHz,  $\text{CD}_3\text{COCD}_3$ ,  $25^\circ\text{C}$ ):  $\delta$  = 6.99 (s, 2H; Ar), 6.93 (s, 4H; Ar), 5.05 (s, 8H;  $\text{PhCH}_2\text{O}$ ), 4.16 (t,  $J$  = 6 Hz, 4H;  $\text{CH}_2\text{O}$ ), 3.10 (t,  $J$  = 6 Hz, 4H;  $\text{NCH}_2$ ), 2.06 (s, 12H;  $\text{CH}_3$ );  $^{13}\text{C}$  NMR (75 MHz,  $\text{CD}_3\text{COCD}_3$ ,  $25^\circ\text{C}$ ):  $\delta$  = 170.7, 160.1, 139.2, 120.4, 114.4, 68.5, 66.0, 20.7; MS (FAB+):  $m/z$  (%) = 546 (3%) [ $M$ +H] $^+$ ;  $\text{C}_{28}\text{H}_{35}\text{NO}_{10}$ ; calcd C 61.64, 6.47, N 2.57; found C 61.65, H 6.48, N 2.49.

**1,3,5-Tris[*N,N*-bis[2-(3,5-bis(acetoxymethyl)phenoxy)ethyl]aminocarbonyl]benzene (13)**: A solution of 1,3,5-benzenetricarbonyl chloride (69.1 mg, 0.26 mmol) in THF (3 mL) was added dropwise with stirring to a mixture of the amine **12** (423 mg, 0.77 mmol) and  $\text{C}_5\text{H}_5\text{N}$  (80  $\mu\text{L}$ , 1 mmol) in THF (20 mL). The reaction mixture was stirred at ambient temperature for 10 min. The solvent was removed in vacuo and then the crude product was subjected to column chromatography on silica gel, eluting with EtOAc to give the protected dendrimer **13** (298 mg, 64%) as a thick oil.  $^1\text{H}$  NMR (400 MHz,  $\text{CD}_3\text{SOCD}_3$ ,  $100^\circ\text{C}$ ):  $\delta$  = 7.63 (s, 3H; Ar[core]), 6.90 (s, 6H; Ar), 6.82 (s, 12H; Ar), 4.99 (s, 24H;  $\text{PhCH}_2\text{O}$ ), 4.18 (br, 12H;  $\text{CH}_2\text{O}$ ), 3.84 (br, 12H;  $\text{NCH}_2$ ), 2.02 (s, 36H;  $\text{CH}_3$ ); MS (FAB+):  $m/z$  (%) = 1815 (100%) [ $M$ +Na] $^+$ ;  $\text{C}_{93}\text{H}_{105}\text{N}_3\text{O}_{33}$ ; HRMS calcd 1814.652 [ $M$ +Na], 1815.656 [ $M$ +Na]; found 1814.660, 1815.667.

**1,3,5-Tris[*N,N*-bis[2-(3,5-bis(hydroxymethyl)phenoxy)ethyl]aminocarbonyl]benzene (14)**: Na metal (60 mg, 2.6 mmol) was dissolved in dry MeOH (10 mL) at  $0^\circ\text{C}$ . A solution of the protected dendrimer **13** (166 mg, 0.87 mmol) in  $\text{CH}_2\text{Cl}_2$  (1 mL) was added and then the reaction mixture was stirred at ambient temperature for 2 h. The mixture was neutralized carefully with 10%  $\text{H}_2\text{SO}_4$ , filtered, and the solvents were removed in vacuo to leave a product, which was purified by HPLC (Phenomenex IB-SIL C-18 column,  $\text{H}_2\text{O}$ ) to give the dendrimer **14** (98 mg, 86%) as a thick oil.  $^1\text{H}$  NMR (400 MHz,  $\text{CD}_3\text{SOCD}_3$ ,  $100^\circ\text{C}$ ):  $\delta$  = 7.60 (s, 3H; Ar[core]), 6.88 (s, 6H; Ar), 6.73 (s, 12H; Ar), 4.70 (brt,  $J$  = 5 Hz, 12H; OH), 4.44 (d,  $J$  = 5 Hz, 24H;  $\text{PhCH}_2\text{O}$ ), 4.15 (brt,  $J$  = 5 Hz, 12H;  $\text{CH}_2\text{O}$ ), 3.81 (brt,  $J$  = 5 Hz, 12H;  $\text{NCH}_2$ );  $^{13}\text{C}$  NMR (100 MHz,  $\text{CD}_3\text{SOCD}_3$ ,  $100^\circ\text{C}$ ):  $\delta$  = 169.6, 157.8, 143.5, 136.7, 125.5, 116.9, 110.8, 65.1, 62.6; MS (FAB+):  $m/z$  (%) = 1288 (59%) [ $M$ +H] $^+$ ;  $\text{C}_{69}\text{H}_{82}\text{N}_3\text{O}_{21}$ ; HRMS calcd 1288.544 [ $M$ +H]; found 1288.545.

***N,N*-Bis[2-(3,5-bis(methoxycarbonyl)phenoxy)ethyl](diethyl)phosphoramidate (15)**: A mixture of the phosphoramidate **7** (8.44 g, 15.4 mmol), the ester **8** (10.59 g, 50.4 mmol), and  $\text{K}_2\text{CO}_3$  (30.0 g, 217 mmol) in MeCN (100 mL) was stirred under reflux in a nitrogen atmosphere for 7 h. The cooled reaction was filtered and the solid was washed with MeCN (10 mL). The solvent was removed in vacuo and the product was crystallized from MeOH/ $\text{H}_2\text{O}$ . Final traces of the phenolic starting material were removed by drying a  $\text{CH}_2\text{Cl}_2$  solution of the product over  $\text{K}_2\text{CO}_3$  to give the phosphoramidate **15** (7.80 g, 84%) as a colorless solid, m.p.  $80$ – $81^\circ\text{C}$ .  $^1\text{H}$  NMR (300 MHz,  $\text{CDCl}_3$ ,  $25^\circ\text{C}$ ):  $\delta$  = 8.23 (t,  $J$  = 1.3 Hz, 2H; Ar), 7.66 (d,  $J$  = 1.5 Hz, 4H; Ar), 4.19 (t,  $J$  = 14.8 Hz, 4H;  $\text{CH}_2\text{OAr}$ ), 4.04 (q,  $J$  = 7.1 Hz, 4H;  $\text{CH}_2\text{OP}$ ), 3.89 (s, 12H;  $\text{CO}_2\text{Me}$ ), 3.58 (m, 6H;  $\text{CH}_3$ ), 1.27 (t,  $J$  = 7.0 Hz, 4H;  $\text{NCH}_2$ );  $^{13}\text{C}$  NMR (75 MHz,  $\text{CDCl}_3$ ,  $25^\circ\text{C}$ ):  $\delta$  = 165.9, 158.6, 131.8, 123.2, 119.6, 67.9, 62.5, 62.4, 52.4, 46.9, 46.8, 16.2;  $^{31}\text{P}$  NMR (162 MHz,  $\text{CDCl}_3$ ,  $25^\circ\text{C}$ ):  $\delta$  = 10.16; MS (FAB+):  $m/z$  (%) = 626 (100) [ $M$ +H] $^+$ ;  $\text{C}_{28}\text{H}_{36}\text{NO}_{13}\text{P}$ ; calcd C 53.76, H 5.80, N 2.24; found C 53.57, H 5.89, N 2.12.

***N,N*-Bis[2-[3,5-bis(hydroxycarbonyl)phenoxy]ethyl](diethyl)phosphoramidate (16):** 15% NaOH (10 mL) was added to a solution of the phosphoramidate **7** (1.083 g, 1.7 mmol) in THF (40 mL). The mixture was stirred under reflux for 2 h and then it was allowed to cool down to room temperature. The THF was removed in vacuo, after which the product was precipitated by the addition of H<sub>2</sub>O (20 mL) and 10% H<sub>2</sub>SO<sub>4</sub> (20 mL). The precipitate was collected by filtration, and was washed with H<sub>2</sub>O (5 mL) to give the phosphoramidate **16** (989 mg, 100%) as a colorless solid, decomp. >250 °C. <sup>1</sup>H NMR (300 MHz, CD<sub>3</sub>SOCD<sub>3</sub>, 25 °C): δ = 13.4 (br, 4H; CO<sub>2</sub>H), 8.06 (brt, 2H; Ar), 7.61 (d, *J* = 1.1 Hz, 4H; Ar), 4.22 (br, 4H; CH<sub>2</sub>O), 3.95 (m, 4H; CH<sub>2</sub>OP), 3.48 (brm, 4H, NCH<sub>2</sub>), 1.20 (t, *J* = 7.2 Hz, 6H; CH<sub>3</sub>); <sup>13</sup>C NMR (75 MHz, CD<sub>3</sub>SOCD<sub>3</sub>, 25 °C): δ = 166.7, 158.8, 133.5, 122.6, 119.0, 66.9, 61.7, 45.6, 16.2; <sup>31</sup>P NMR (162 MHz, CD<sub>3</sub>SOCD<sub>3</sub>, 25 °C): δ = 10.51; MS (FAB<sup>−</sup>): *m/z* (%) = 568 (100) [*M* − H]<sup>+</sup>; C<sub>24</sub>H<sub>28</sub>N<sub>2</sub>O<sub>13</sub>P; calcd C 50.62, H 4.96, N 2.46; found C 50.48, H 4.94, N 2.26.

**Bis[2-[3,5-bis(methoxycarbonyl)phenoxy]ethyl]amine (17):** A solution of the phosphoramidate **7** (2.28 g, 3.6 mmol) in THF (50 mL) was cooled down to below 5 °C. HCl gas was bubbled through the solution for 30 min, after which time the cold bath was removed and the reaction mixture was left to stand for 3 h. The volatiles were removed in vacuo, and then Et<sub>2</sub>O (50 mL) was added. The crude HCl salt was isolated by filtration, and was washed with Et<sub>2</sub>O (10 mL). The HCl salt was dissolved in H<sub>2</sub>O/MeOH (ca. 10 mL) and the free amine was precipitated in pure form by the addition of 15% NaOH solution (2.5 mL). The product was isolated by filtration, and then washed with H<sub>2</sub>O (2 mL). Finally, the pure material was dried in a desiccator to give the amine **17** (1.49 g, 84%) as a colorless solid, m.p. 131–132 °C. <sup>1</sup>H NMR (300 MHz, CD<sub>3</sub>COCD<sub>3</sub>, 25 °C): δ = 8.61 (t, *J* = 1.5 Hz, 2H; Ar), 8.18 (d, *J* = 1.5 Hz, 4H; Ar), 4.69 (t, *J* = 5.5 Hz, 4H; CH<sub>2</sub>OAr), 4.37 (s, 12H; CH<sub>3</sub>), 3.59 (t, *J* = 5.3 Hz, 4H; NCH<sub>2</sub>); <sup>13</sup>C NMR (75 MHz, CD<sub>3</sub>COCD<sub>3</sub>, 25 °C): δ = 166.2, 160.2, 132.9, 132.0, 120.3, 69.5, 52.7, 49.1; MS (FAB<sup>+</sup>): *m/z* (%) = 490 (100) [*M* + H]<sup>+</sup>; C<sub>24</sub>H<sub>27</sub>N<sub>2</sub>O<sub>10</sub>; calcd C 61.00, H 6.26, N 2.63; found C 61.26, H 6.27, N 2.61.

***N,N*-Bis[2-[3,5-bis(*N,N*-bis(2-(3,5-bis(methoxycarbonyl)phenoxy)ethyl)-aminocarbonyl)phenoxy]ethyl](diethyl)phosphoramidate (18):** A solution of the amine **17** (6.545 g, 13.4 mmol) and the phosphoramidate **16** (1.901 g, 3.34 mmol) in THF (150 mL) was cooled down to 0 °C. DCC (2.85 g, 13.8 mmol) and HOBT (1.82 g, 13.5 mmol) were added, the ice-bath was removed, and the reaction mixture was stirred for 4 h. The solvent was removed in vacuo and the product was isolated by flash column chromatography on silica gel, eluting with a gradient from EtOAc to 10% MeOH in EtOAc to give the phosphoramidate **18** (7.60 g, 93%) as a colorless, amorphous solid. <sup>1</sup>H NMR (400 MHz, CD<sub>3</sub>SOCD<sub>3</sub>, 100 °C): δ = 7.94 (t, *J* = 1.3 Hz, 8H; Ar), 7.50 (d, *J* = 1.3 Hz, 16H; Ar), 7.19 (brt, 2H; Ar), 7.06 (d, *J* = 1.2 Hz, 4H, Ar), 4.28 (t, *J* = 5.1 Hz, 16H; CH<sub>2</sub>OAr), 4.18 (t, *J* = 5.7 Hz, 4H; CH<sub>2</sub>OAr), 3.9–3.8 (m, 68H; NCH<sub>2</sub>, CH<sub>2</sub>OP, CO<sub>2</sub>CH<sub>3</sub>), 3.44 (m, 4H; PNCH<sub>2</sub>), 1.14 (t, *J* = 7.0 Hz, 6H; CH<sub>3</sub>); <sup>13</sup>C NMR (75 MHz, CD<sub>3</sub>SOCD<sub>3</sub>, 25 °C): δ = 171.6, 165.8, 159.4, 159.1, 139.2, 132.3, 123.0, 119.8, 118.9, 114.8, 62.4, 62.1, 52.5, 16.4, 16.3; <sup>31</sup>P NMR (162 MHz, CD<sub>3</sub>SOCD<sub>3</sub>, 25 °C): δ = 10.38; MS (FAB<sup>+</sup>): *m/z* (%) = 2456 (100) [*M* + H]<sup>+</sup>; C<sub>120</sub>H<sub>128</sub>N<sub>5</sub>O<sub>49</sub>P; calcd C 50.70, H 5.25, N 2.85; found C 50.85, H 5.31, N 2.79.

**1,3,5-Tris[*N,N*-bis(2-(3,5-bis(methoxycarbonyl)phenoxy)ethyl)aminocarbonyl]benzene (19):** A solution of the amine **17** (765 mg, 1.56 mmol) and trimesic acid (109 mg, 0.52 mmol) in THF (75 mL) was cooled down to 0 °C. DCC (322 mg, 1.56 mmol) and HOBT (199 mg, 1.47 mmol) were added, the ice bath was removed, and the reaction mixture was stirred for 4 h. The solvent was removed in vacuo and the product was isolated by flash column chromatography on silica gel, eluting with a gradient from EtOAc to 10% MeOH in EtOAc to give the dendrimer **19** (590 mg, 70%) as a colorless, amorphous solid. <sup>1</sup>H NMR (400 MHz, CD<sub>3</sub>SOCD<sub>3</sub>, 100 °C): δ = 7.92 (t, *J* = 1.2 Hz, 6H; Ar), 7.74 (s, 3H; core Ar), 7.49 (d, *J* = 1.3 Hz, 12H; Ar), 4.29 (t, *J* = 5.1 Hz, 12H; CH<sub>2</sub>OAr), 3.91 (t, *J* = 5.1 Hz, 12H, NCH<sub>2</sub>), 3.84 (s, 36H; CH<sub>3</sub>); <sup>13</sup>C NMR (100 MHz, CD<sub>3</sub>SOCD<sub>3</sub>, 100 °C): δ = 169.7, 164.5, 158.0, 136.6, 131.2, 125.9, 121.7, 118.8, 66.1, 51.6, 46.7; MS (FAB<sup>+</sup>): *m/z* (%) = 1414 (96) [*M* − OPh(CO<sub>2</sub>Me)<sub>2</sub>]<sup>+</sup>, 1624 (100) [*M* + H]<sup>+</sup>; C<sub>81</sub>H<sub>81</sub>N<sub>3</sub>O<sub>33</sub>; calcd C 59.89, H 5.03, N 2.59; found C 59.84, H 5.17, N 2.63.

**1-Methoxycarbonyl-3,5-bis[*N,N*-bis(2-(3,5-bis(methoxycarbonyl)phenoxy)ethyl)aminocarbonyl]benzene (21):** A solution of the amine **17** (452 mg, 0.92 mmol) and trimesic acid (64 mg, 0.30 mmol) in MeCN (20 mL) was cooled down to 0 °C. DCC (196 mg, 0.95 mmol), HOBT (128 mg, 0.95 mmol), and THF (5 mL) were added and the ice-bath was removed. The reaction mixture was stirred for 3 h, after which time the

solvent was removed in vacuo. The product was isolated by flash column chromatography on silica gel, eluting with EtOAc to give the dendrimer **21** (122 mg, 34%) as an amorphous solid. <sup>1</sup>H NMR (400 MHz, CD<sub>3</sub>SOCD<sub>3</sub>, 100 °C): δ = 8.04 (d, *J* = 1.6 Hz, 2H; Ar[core]), 7.97 (t, *J* = 1.4 Hz, 8H; Ar), 7.84 (t, *J* = 1.6 Hz, 1H; Ar[core]), 7.53 (d, *J* = 1.4 Hz, 4H; Ar), 4.31 (t, *J* = 10 Hz, 8H; CH<sub>2</sub>O), 3.88 (t, obscured; NCH<sub>2</sub>), 3.85 (s, 27H; CH<sub>3</sub>); <sup>13</sup>C NMR (100 MHz, CD<sub>3</sub>SOCD<sub>3</sub>, 100 °C): δ = 169.4, 164.5, 158.0, 136.8, 131.2, 129.9, 129.0, 127.8, 124.3, 121.6, 118.8, 65.9, 51.6, 45.5; MS (FAB<sup>+</sup>): *m/z* (%) = 1167 (85%) [*M* + H]<sup>+</sup>; C<sub>38</sub>H<sub>38</sub>N<sub>2</sub>O<sub>24</sub>; calcd C 59.69, H 5.01, N 2.40; found C 59.6, H 4.91, N 2.25.

**1,3,5-Tris[*N,N*-bis(2-(3,5-bis(hydroxycarbonyl)phenoxy)ethyl)aminocarbonyl]benzene (22):** A 7.5% aqueous solution of NaOH (1.5 mL) was added to a stirred solution of the dendrimer **19** (665 mg, 0.41 mmol) in THF (15 mL). The reaction mixture was stirred under reflux for 1 h, after which time 15% aqueous NaOH solution (1.5 mL) was added. The reaction mixture was stirred under reflux for a further 1 h and then the THF was removed in vacuo. The product was precipitated by the addition of a 10% aqueous solution (10 mL) of H<sub>2</sub>SO<sub>4</sub>. It was collected by filtration and then washed with H<sub>2</sub>O (10 mL) and dried in a desiccator to give the dodecaacid **22** (630 mg, 100%) as a white powder. <sup>1</sup>H NMR (400 MHz, CD<sub>3</sub>SOCD<sub>3</sub>, 90 °C): δ = 8.02 (6H; Ar[surface]), 7.74 (s, 3H; Ar[core]), 7.59 (12H; Ar[surface]), 4.30 (brt, 12H; CH<sub>2</sub>O), 3.91 (brt, 12H; NCH<sub>2</sub>); <sup>13</sup>C NMR (100 MHz, CD<sub>3</sub>SOCD<sub>3</sub>, 90 °C): δ = 169.6, 165.6, 157.8, 136.5, 132.2, 125.8, 122.2, 118.7, 65.6; MS (FAB<sup>−</sup>): *m/z* (%) = 1455 (100%) [*M* − H]<sup>−</sup>.

**Bis[2-[3,5-bis(*N,N*-bis(2-(3,5-bis(methoxycarbonyl)phenoxy)ethyl)aminocarbonyl)phenoxy]ethyl]amine (24):** A solution of the phosphoramidate **18** (5.188 g, 2.11 mmol) in THF (100 mL) was cooled down to below 5 °C. HCl gas was bubbled through the solution for 30 min, after which time the cold bath was removed and the reaction was left to stand for 2 h while the reaction was monitored by TLC. The volatiles were removed in vacuo and then Et<sub>2</sub>O (100 mL) was added. The Et<sub>2</sub>O was decanted and the solid was dissolved in the minimum volume of Me<sub>2</sub>CO. The free amine was precipitated by the addition of a 15% NaOH solution (2 mL) and H<sub>2</sub>O (100 mL). The crude product was isolated by filtration, then purified by flash column chromatography on silica gel, eluting with a gradient from 10% MeOH in EtOAc to 1:1:8 Et<sub>3</sub>N:MeOH:EtOAc to give the amine **24** (3.52 g, 72%) as a colorless amorphous solid. <sup>1</sup>H NMR (400 MHz, CD<sub>3</sub>SOCD<sub>3</sub>, 100 °C): δ = 7.95 (t, *J* = 1.5 Hz, 8H; Ar[outer]), 7.52 (d, *J* = 1.3 Hz, 16H; Ar[outer]), 7.17 (s, 2H; Ar[inner]), 7.06 (s, 4H; Ar[inner]), 4.29 (t, *J* = 5.0 Hz, 16H; CH<sub>2</sub>O[outer]), 4.10 (t, *J* = 5.6 Hz, 4H; CH<sub>2</sub>O[inner]), 3.87 (observed; NCH<sub>2</sub>[outer]), 3.84 (s, 48H; CH<sub>3</sub>), 3.01 (t, *J* = 5.6 Hz, 4H; NCH<sub>2</sub>[inner]); <sup>13</sup>C NMR (75 MHz, CD<sub>3</sub>COCD<sub>3</sub>, 25 °C): δ = 171.7, 165.9, 159.7, 159.2, 139.1, 132.4, 123.0, 119.8, 118.8, 115.0, 69.0, 67.4, 52.6, 50.1, 49.0, 46.2; MS (FAB<sup>+</sup>): *m/z* (%) = 2320 (70%) [*M* + H]<sup>+</sup>; C<sub>108</sub>H<sub>119</sub>N<sub>5</sub>O<sub>46</sub>; calcd C 60.08, H 5.17, N 3.02; found C 60.54, H 5.18, N 3.16.

**1,3,5-Tris[*N,N*-bis(2-(3,5-bis(*N,N*-bis(2-(3,5-bis(methoxycarbonyl)phenoxy)ethyl)aminocarbonyl)phenoxy)ethyl)aminocarbonyl]benzene (26), Method A:** A solution of the amine **24** (142 mg, 0.061 mmol) in THF (15 mL) was cooled down to < 5 °C. A solution of 1,3,5-benzenetricarbonyl trichloride (5.0 mg, 0.053 mmol) in THF (160 μL) was added slowly using a syringe, while the reaction mixture was stirred and allowed to warm up to ambient temperature. After stirring for a further 1 h, the solvent was removed in vacuo and the product was isolated by column chromatography on silica gel, eluting with a gradient from EtOAc to 10% MeOH in EtOAc to give the three-directional dendrimer **26** (91 mg, 63%) as a colorless amorphous solid. <sup>1</sup>H NMR (400 MHz, CD<sub>3</sub>SOCD<sub>3</sub>, 100 °C): δ = 7.83 (t, *J* = 1.3 Hz, 24H; Ar[outer]), 7.76 (s, 3H; Ar[core]), 7.40 (d, *J* = 1.7 Hz, 48H; Ar[outer]), 7.23 (brt, 6H; Ar[inner]), 7.10 (d, *J* = 1.4 Hz, 12H; Ar[inner]) 4.30 (brt, 12H; CH<sub>2</sub>O[inner]), 4.20 (brt, 48H; CH<sub>2</sub>O[outer]), 3.90 (brt, 12H; NCH<sub>2</sub>[inner]), 3.83 (brt, 48H; NCH<sub>2</sub>[outer]), 3.77 (s, 144H; CH<sub>3</sub>); <sup>13</sup>C NMR (100 MHz, CD<sub>3</sub>SOCD<sub>3</sub>, 100 °C): δ = 169.9, 169.7, 164.4, 157.8, 137.6, 136.4, 131.0, 127, 121.7, 121.5, 118.7, 117.5, 117.3, 113.8, 113.6, 66.5, 66.1, 65.7, 52.2, 51.5, 50.8, 46.6; MS (FAB<sup>+</sup>): *m/z* (%) = 7113 (3) [*M* + H]<sup>+</sup>; C<sub>357</sub>H<sub>357</sub>N<sub>15</sub>O<sub>41</sub>; calcd C 60.28, H 5.06, N 2.95; found C 59.97, H 5.20, N 2.85.

**Dendrimer 26 (Method B) and 1-methoxycarbonyl-3,5-tris[*N,N*-bis(2-(3,5-bis(*N,N*-bis(2-(3,5-bis(methoxycarbonyl)phenoxy)ethyl)aminocarbonyl)phenoxy)ethyl)aminocarbonyl]benzene (25):** A solution of the amine **24** (1.09 g, 0.47 mmol) and trimesic acid (32.7 mg, 0.156 mmol) in THF (20 mL) was cooled down to 0 °C. DCC (99 mg, 0.48 mmol) and HOBT (74 mg, 0.48 mmol) were added, the ice-bath was removed, and the reaction was stirred for 12 h. The solvent was removed in vacuo and then the

products were isolated by flash column chromatography on silica gel, eluting with a gradient from EtOAc to 10% MeOH in EtOAc to give the three-directional dendrimer **26** (144 mg, 13%) and the two-directional dendrimer **25** (237 mg, 32%) as a colorless, amorphous solid.  $^1\text{H}$  NMR (400 MHz,  $\text{CD}_3\text{SOCD}_3$ ,  $100^\circ\text{C}$ ):  $\delta$  = 8.05 (d,  $J$  = 1.5 Hz, 2H; Ar[core]), 7.88 (t,  $J$  = 1.3 Hz, 16H; Ar[outer]), 7.79 (t,  $J$  = 1.3 Hz, 1H; Ar[core]), 7.45 (d,  $J$  = 1.4 Hz, 32H; Ar[outer]), 7.21 (brt, 4H; Ar[inner]), 7.09 (d,  $J$  = 1.2 Hz, 8H; Ar[inner]) 4.25 (m, 40H;  $\text{CH}_2\text{O}$ [inner + outer]), 3.85 (m, 40H;  $\text{NCH}_2$ [inner + outer]), 3.80 (s, 99H;  $\text{CH}_3$ [core + surface]);  $^{13}\text{C}$  NMR (100 MHz,  $\text{CD}_3\text{SOCD}_3$ ,  $90^\circ\text{C}$ ):  $\delta$  = 169.9, 169.3, 164.4, 157.8, 137.6, 136.8, 131.0, 129.5, 127.7, 121.5, 118.7, 117.4, 113.6, 66.0, 65.4, 51.5; MS (FAB+):  $m/z$  (%) = 4827 (27)  $[M+H]^+$ ;  $\text{C}_{242}\text{H}_{242}\text{N}_{10}\text{O}_{96}$ : calcd C 60.22, H 5.05, N 2.90; found C 60.30, H 5.19, N 2.88.

**1,3,5-Tris[*N,N*-bis[2-(3,5-bis(*N,N*-bis[2-(3,5-bis(*N,N*-bis[2-(3,5-bis(methoxycarbonyl)phenoxy)ethyl]aminocarbonyl)phenoxy)ethyl]aminocarbonyl)phenoxy]ethyl]aminocarbonyl]benzene (27)**: A solution of the amine **24** (1.09 g, 0.47 mmol) and the dodecaacid **22** (56.2 mg, 0.039 mmol) in THF (25 mL) was cooled down to  $0^\circ\text{C}$ . DCC (110 mg, 0.53 mmol) and HOBt (77 mg, 0.50 mmol) were added, the ice-bath was removed, and the reaction mixture was stirred overnight. More DCC (90 mg, 0.44 mmol) was added and the reaction mixture was stirred for a further day. The solvent was removed in vacuo to give a crude mixture. Quantitative GPC of an aliquot of this mixture showed that it contained products with a narrow hydrodynamic radius range of around 2.4 nm and a yield of 32% with respect to the wedge.

***N,N*-Bis[2-[3,5-bis(methoxycarbonyl)phenoxy]ethyl]benzamide (29)**: A solution of the amine **17** (266 mg, 0.544 mmol) and benzoic acid (72 mg, 0.59 mmol) in THF (20 mL) was cooled down to  $0^\circ\text{C}$ . DCC (122 mg, 0.59 mmol) and HOBt (81 mg, 0.60 mmol) were added, the ice-bath was removed, and the reaction mixture was stirred for 5 h. The solvent was removed in vacuo and the product was isolated by flash column chromatography on silica gel, eluting with a gradient from EtOAc to 10% MeOH in EtOAc to give the amide **29** (252 mg, 78%) as a colorless, amorphous solid.  $^1\text{H}$  NMR (300 MHz,  $\text{CD}_3\text{COCD}_3$ ,  $25^\circ\text{C}$ ):  $\delta$  = 8.10 (t,  $J$  = 3 Hz, 2H; Ar[branching unit]), 7.63 (d,  $J$  = 3 Hz, 4H; Ar[branching unit]), 7.55 (m, 2H; Ar[core]), 7.45 (m, 3H; Ar[core]), 4.40 (br, 4H;  $\text{CH}_2\text{O}$ ), 4.06 (br, 4H;  $\text{NCH}_2$ ), 3.90 (s, 12H;  $\text{CH}_3$ );  $^{13}\text{C}$  NMR (100 MHz,  $\text{CD}_3\text{SOCD}_3$ ,  $90^\circ\text{C}$ ):  $\delta$  = 171.3, 164.8, 158.2, 136.3, 131.4, 128.8, 127.8, 126.4, 121.7, 119.0, 66.3, 51.8; MS (FAB+):  $m/z$  (%) = 594 (43%)  $[M+H]^+$ ;  $\text{C}_{51}\text{H}_{51}\text{NO}_{11}$ : calcd C 62.73, H 5.26, N 2.36; found C 62.89, H 5.19, N 2.19.

***N,N*-Bis[2-[3,5-bis(*N,N*-bis[2-(3,5-bis(methoxycarbonyl)phenoxy)ethyl]aminocarbonyl)phenoxy]ethyl]aminocarbonylbenzamide (30)**: A solution of the amine **24** (126 mg, 0.054 mmol) and benzoic acid (7.3 mg, 0.060 mmol) in THF (2 mL) was cooled down to  $0^\circ\text{C}$ . DCC (12.7 mg, 0.62 mmol) and HOBt (8.1 mg, 0.060 mmol) were added, the ice-bath was removed, and the reaction mixture was stirred overnight. The solvent was removed in vacuo and then the product was isolated by flash column chromatography on silica gel, eluting with a gradient from EtOAc to 10% MeOH in EtOAc to give the amide **30** (125 mg, 95%) as a colorless, amorphous solid.  $^1\text{H}$  NMR (400 MHz,  $\text{CD}_3\text{SOCD}_3$ ,  $100^\circ\text{C}$ ):  $\delta$  = 7.94 (t,  $J$  = 1.4 Hz, 8H; Ar[outer]), 7.50 (d,  $J$  = 1.5 Hz, 16H; Ar[outer]), 7.29 (m, 5H; Ar[core]), 7.20 (t,  $J$  = 1.2 Hz, 2H; Ar[inner]), 7.06 (d,  $J$  = 1.2 Hz, 4H; Ar[inner]), 4.28 (t,  $J$  = 5.1 Hz, 16H;  $\text{CH}_2\text{O}$ [outer]), 4.24 (t,  $J$  = 5.6 Hz, 4H;  $\text{CH}_2\text{O}$ [inner]), 3.88 (m, 20H;  $\text{NCH}_2$ [inner + outer]), 3.83 (s, 48H;  $\text{CH}_3$ );  $^{13}\text{C}$  NMR (100 MHz,  $\text{CD}_3\text{SOCD}_3$ ,  $100^\circ\text{C}$ ):  $\delta$  = 170.0, 164.6, 158.0, 137.8, 136.2, 131.2, 128.5, 127.6, 126.1, 124.3, 121.7, 118.8, 117.4, 113.7, 66.1, 65.7, 51.6, 46.1 (br); MS (FAB+):  $m/z$  (%) = 2446 (100%)  $[M+H]^+$ ;  $\text{C}_{123}\text{H}_{123}\text{N}_5\text{O}_{47}$ : calcd C 60.96, H 5.12, N 2.89; found C 61.08, H 5.17, N 2.93.

**1,3,5-Tris(methoxycarbonyl)benzene (31)**: A solution of trimesic acid (24.5 g, 97 mmol) and  $\text{H}_2\text{SO}_4$  (25 mL) in MeOH (250 mL) was stirred under reflux for 18 h. The reaction mixture was cooled down to  $5^\circ\text{C}$  and  $\text{H}_2\text{O}$  (150 mL) was added. The precipitated product was isolated by filtration and was washed with  $\text{H}_2\text{O}$  (50 mL) to give the pure triester **31** (28.5 g, 97%) as a colorless solid, m.p.  $145\text{--}146^\circ\text{C}$ ; Lit.  $145\text{--}147^\circ\text{C}$  (Aldrich).  $^1\text{H}$  NMR (300 MHz,  $\text{CD}_3\text{COCD}_3$ ,  $25^\circ\text{C}$ ):  $\delta$  = 8.34 (s, 3H; Ar), 3.98 (s, 9H;  $\text{CH}_3$ ).

**Acknowledgments**: This research was supported by the Chemical and Biological Defence Establishment of the Defence Evaluation and Research Agency of the Ministry of Defence in the United Kingdom.

Received: September 15, 1997 [F821]

- [1] A search of the Science Citation Index with the keyword dendrimer reveals hits for the last five years as follows: 1991, 3; 1992, 11; 1993, 19; 1994, 30; 1995, 36; 1996, 60. For recent reviews concerning dendrimers, see: a) H. B. Meikelburger, W. Jaworek, F. Vögtle, *Angew. Chem.* **1992**, *104*, 1609–1614; *Angew. Chem. Int. Ed. Engl.* **1992**, *31*, 1571–1576; b) G. R. Newkome, C. N. Moorefield, G. R. Baker, *Aldrichimica Acta* **1992**, *25*, 31–38; c) D. A. Tomalia, *Adv. Mater.* **1994**, *6*, 529–539; d) G. R. Newkome, C. N. Moorefield in *Comprehensive Supramolecular Chemistry*, Vol. 10 (Ed.: D. N. Reinhoudt), Pergamon, Oxford, UK, **1996**, 777–832; e) J. M. J. Fréchet, C. J. Hawker in *Comprehensive Polym. Sci.* (Eds.: S. L. Aggarwal, S. Russo), **1996**, 140–201; f) G. R. Newkome, C. N. Moorefield, F. Vögtle in *Dendritic Molecules*, VCH, Weinheim, Germany, **1996**; g) O. A. Matthews, A. N. Shipway, J. F. Stoddart, *Prog. Polym. Sci.* **1998**, *23*, 1–56.
- [2] D. A. O'Sullivan, *Chem. Eng. News* **1993**, August 16, 20–23; the PAMAM dendrimers are commercially available through Aldrich.
- [3] H. Brunner, *J. Organomet. Chem.* **1995**, *500*, 39–46.
- [4] a) J. R. Robinson, G. M. Mlynek, *Adv. Drug Deliv. Rev.* **1995**, *16*, 45–50; b) A. E. Beezer, J. C. Mitchell, R. M. Colegate, D. J. Scally, L. J. Twyman, R. J. Willson, *Thermochim. Acta.* **1995**, 277–283; c) K. Sheldon, D. Liu, J. Ferguson, J. Gariépy, *Proc. Natl. Acad. Sci. USA* **1995**, *92*, 2056–2060.
- [5] a) D. A. Tomalia, P. R. Dvornic, *Nature* **1994**, *372*, 617–618; b) J. Alper, *Science* **1991**, *251*, 1562–1564.
- [6] a) D. A. Tomalia, M. Hall, D. M. Hedstrand, *J. Am. Chem. Soc.* **1987**, *109*, 1601–1603; b) A. M. Naylor, W. A. Goddard III, G. E. Kiefer, D. A. Tomalia, *ibid.* **1989**, *111*, 2339–2341.
- [7] a) J. F. G. A. Jansen, R. A. J. Janssen, E. M. M. de Brabander-vanden Berg, E. W. Meijer, *Adv. Mater.* **1995**, *7*, 561–564; b) K. L. Wooley, C. J. Hawker, J. M. Pochan, J. M. J. Fréchet, *Macromolecules* **1993**, *26*, 1514–1519; c) G. R. Newkome, C. N. Moorefield, J. M. Keith, G. R. Baker, G. H. Escamilla, *Angew. Chem.* **1994**, *106*, 701–703; *Angew. Chem. Int. Ed. Engl.* **1994**, *33*, 666–668; d) G. R. Newkome, C. N. Moorefield, G. R. Baker, R. K. Behera, G. H. Escamilla, M. J. Sanders, *ibid.* **1992**, *104*, 901–903 and **1992**, *31*, 917–919; e) D. A. Tomalia, A. M. Naylor, W. A. Goddard III, *ibid.* **1990**, *102*, 119–157 and **1990**, *29*, 138–175.
- [8] R. F. Service, *Science* **1995**, *267*, 458–459.
- [9] G. R. Newkome, C. N. Moorefield, G. R. Baker, M. J. Saunders, S. H. Grossman, *Angew. Chem.* **1991**, *103*, 1207–1209; *Angew. Chem. Int. Ed. Engl.* **1991**, *30*, 1178–1180.
- [10] M. F. Ottaviani, S. Bossmann, N. J. Turro, D. A. Tomalia, *J. Am. Chem. Soc.* **1994**, *116*, 661–671.
- [11] D. A. Tomalia, H. Baker, J. Dewald, M. Hall, G. Kallos, S. Martin, J. Roeck, J. Ryder, P. Smith, *Polym. J.* **1985**, *17*, 117–132.
- [12] C. J. Hawker, K. L. Wooley, J. M. J. Fréchet, *J. Am. Chem. Soc.* **1993**, *115*, 4375–4376.
- [13] M. L. Mansfield, L. I. Klushin, *Macromolecules* **1993**, *26*, 4262–4268.
- [14] C. J. Hawker, J. M. J. Fréchet, *J. Am. Chem. Soc.* **1990**, *112*, 7638–7647.
- [15] Many dendrimer syntheses rely on the so-called divergent approach and date back to the seminal paper demonstrating the feasibility of dendrimer synthesis. See: E. Buhleier, W. Wehner, F. Vögtle, *Synthesis* **1978**, 155–158.
- [16] M. L. Mansfield, *Macromolecules* **1993**, *26*, 3811–3814.
- [17] K. L. Wooley, C. J. Hawker, J. M. J. Fréchet, *J. Chem. Soc. Perkin Trans. I* **1991**, 1059–1076.
- [18] J. M. J. Fréchet, C. J. Hawker, K. L. Wooley, *J. Macromol. Sci. Pure Appl. Chem.* **1994**, *A31*, 1627–1645.
- [19] a) S. Campagna, G. Denti, S. Serroni, A. Juris, M. Venturi, V. Ricevuto, V. Balzani, *Chem. Eur. J.* **1995**, *1*, 211–220; b) H.-F. Chow, C. C. Mak, *J. Chem. Soc. Perkin Trans. I* **1994**, 2223–2228; c) N. Launay, A.-M. Caminade, J.-P. Majoral, *J. Am. Chem. Soc.* **1995**, *117*, 3282–3283; d) A. Rajca, S. Utamapanya, *ibid.* **1993**, *115*, 10688–10694; e) S. Achar, R. J. Puddephatt, *J. Chem. Soc. Chem. Commun.* **1994**, 1895–1896; f) R. H. E. Hudson, M. J. Damha, *J. Am. Chem. Soc.* **1993**, *115*, 2119–2124; g) D. Seyferth, D. Y. Son, A. L. Rheingold, R. L. Ostrander, *Organometallics* **1994**, *13*, 2682–2690.
- [20] K. L. Wooley, C. J. Hawker, J. M. J. Fréchet, *J. Am. Chem. Soc.* **1991**, *113*, 4252–4261.
- [21] K. L. Wooley, C. J. Hawker, J. M. J. Fréchet, *Angew. Chem. Int. Ed.* **1994**, *106*, 123–126; *Angew. Chem. Int. Ed. Engl.* **1994**, *33*, 82–85.

- [22] R. Spindler, *J. Chem. Soc. Perkin Trans. 1* **1993**, 913–918.
- [23] T. Kawaguchi, K. L. Walker, C. L. Wilkins, J. S. Moore, *J. Am. Chem. Soc.* **1995**, *117*, 2159–2165.
- [24] For an exception to this rule, see: R. Spindler, J. M. J. Fréchet, *J. Chem. Soc. Perkin Trans. 1* **1993**, 913–918.
- [25] C. J. Hawker, J. M. J. Fréchet, *J. Chem. Soc. Perkin Trans. 1* **1992**, 2459–2469.
- [26] a) H.-F. Chow, C. C. Mak, *J. Chem. Soc. Perkin Trans. 1* **1994**, 2223–2228; b) S. Achar, R. J. Puddephatt, *Organometallics* **1995**, *14*, 1681–1687; c) D. Seyferth, D. Y. Son, *ibid.* **1994**, *13*, 2682–2690; d) K. Rengan, R. Engel, *J. Chem. Soc. Perkin Trans. 1* **1991**, 987–990.
- [27] a) E. M. M. de Brabander-van den Berg, E. W. Meijer, *Angew. Chem.* **1993**, *105*, 1370–1372; *Angew. Chem. Int. Ed. Engl.* **1993**, *32*, 1308–1311; b) N. Launay, A. M. Caminade, J.-P. Majoral, *J. Am. Chem. Soc.* **1995**, *117*, 3282–3283.
- [28] a) G. R. Newkome, V. V. Narayanan, A. K. Patri, J. Gross, C. N. Moorefield, G. R. Baker, *Proc. ACS Division of Polymeric Materials: Sci. Eng.* **1995**, *73*, 222–223; b) A. Rajca, S. Utamapanya, *J. Am. Chem. Soc.* **1993**, *115*, 10688–10694; c) T. Nagasaki, O. Kimura, M. Ukon, S. Arimori, I. Hamachi, S. Shinkai, *J. Chem. Soc. Perkin Trans. 1* **1994**, 75–81; d) H. Uchida, Y. Kabe, K. Yoshino, A. Kawamata, T. Tsumuraya, S. Masumune, *J. Am. Chem. Soc.* **1990**, *112*, 7077–7079.
- [29] K. L. Wooley, C. J. Hawker, J. M. J. Fréchet, *Angew. Chem. Int. Ed. Engl.* **1994**, *33*, 82–85.
- [30] a) T. Kawaguchi, K. L. Walker, C. L. Wilkins, J. S. Moore, *J. Am. Chem. Soc.* **1995**, *117*, 2159–2165; b) A. Miedaner, C. J. Curtis, R. M. Barkley, D. L. DuBois, *Inorg. Chem.* **1994**, *33*, 5482–5490.
- [31] C. J. Hawker, J. M. J. Fréchet, *J. Am. Chem. Soc.* **1992**, *114*, 8405–8413.
- [32] E. H. Gold, E. Babad, *J. Org. Chem.* **1972**, *37*, 2208–2210.
- [33] a) E. Amble, J. Dale, *Acta Chem. Scand.* **1979**, *33*, 698–700; b) P. J. Maurer, H. Takahata, H. Rapoport, *J. Am. Chem. Soc.* **1984**, *106*, 1095–1098; c) T. Hamada, *J. Am. Chem. Soc.* **1986**, *108*, 140–145; d) W. Yuan, K. Fearon, M. H. Gelb, *J. Org. Chem.* **1989**, *54*, 906–910.
- [34] a) S. J. Blarer, D. Seebach, *Chem. Ber.* **1983**, *116*, 2250; b) T. P. Curran, M. P. Pollastri, S. M. Abelleira, R. J. Messier, T. A. McCollum, C. G. Rowe, *Tetrahedron Lett.* **1994**, *35*, 5409–5412.
- [35] L. Qian, Z. Sun, M. P. Mertes, K. B. Mertes, *J. Org. Chem.* **1991**, *56*, 4904–4907.
- [36] A. Zwierak, K. Osowska, *Synthesis* **1984**, 223–224.
- [37] a) S. K. Banerjee, B. D. Gupta, K. Singh, *J. Chem. Soc. Chem. Commun.* **1982**, 815–816; b) H. E. Zaugg, *J. Org. Chem.* **1976**, *41*, 3419–3421.
- [38] A. N. Shipway, J. F. Stoddart, unpublished results.
- [39] R. G. Denkewalter, J. Kolc, W. J. Lusksavage, US Patent 4289872, **1981**.
- [40] L. J. Twyman, A. E. Beezer, J. C. Mitchell, *Tetrahedron Lett.* **1994**, *35*, 4423–4424.
- [41] T. Nagasaki, O. Kimura, M. Ukon, I. Hamachi, S. Shinkai, *J. Chem. Soc. Perkin Trans. 1* **1994**, 75–81.
- [42] K. E. Uhrich, J. M. J. Fréchet, *J. Chem. Soc. Perkin Trans. 1* **1992**, 1623–1630.
- [43] P. J. Dandliker, F. Diederich, M. Gross, C. B. Knobler, A. Louati, E. M. Sanford, *Angew. Chem.* **1994**, *106*, 1821–1824; *Angew. Chem. Int. Ed. Engl.* **1994**, *33*, 1739–1742.
- [44] An aliquot (39 mg) of the crude reaction mixture, which contained 34 mg of dendritic materials with respect to the starting amine, was estimated by GPC to contain 10.9 mg of sixth-generation products.
- [45] a) B. L. Schwartz, A. L. Rockwood, R. D. Smith, D. A. Tomalia, R. Spindler, *Rapid Commun. Mass Spectrom.* **1995**, *9*, 1552–1555; b) P. R. Dvornic, D. A. Tomalia, *Macromol. Symp.* **1995**, *98*, 403–428; c) J. W. Leon, J. M. J. Fréchet, *Polym. Bull.* **1995**, *35*, 449–455.
- [46] M. J. Maciejewski, *J. Macromol. Sci. Chem.* **1982**, *A17(4)*, 689–703.
- [47] The fourth-generation dendrimer carries four times the number of end groups and has twice the arm length (hence four times the surface area) of its second-generation analogue. The transformation from a free to a globular dendrimer conformation is usually associated with an increase in the end group:surface area ratio.
- [48] The calibration data was obtained by examining a set of nine low polydispersity polystyrene standards and the average hydrodynamic radii of the samples was calculated from the equation  $d = (240/\pi N)^{1/3} (M[\eta])^{1/3}$ , where  $d$  is the average hydrodynamic diameter,  $M$  is the molecular weight,  $[\eta]$  is the intrinsic viscosity of the analyte, and  $N$  is a constant. Standard GPC calibration curves for molecular size (R. D. Hester, P. H. Mitchell, *J. Polym. Sci. Chem. Ed.* **1980**, *18*, 1727–1738) were found to be unsatisfactory. This observation may be a consequence of a GPC system consisting of two columns of different pore sizes, linked in series. An excellent fit ( $R^2 = 0.999$ ) was found for the relationship  $r = aV_e^b$  (without a theoretical basis), where  $r$  is the average hydrodynamic radius,  $V_e$  is the elution volume, and  $a$  and  $b$  are constants.
- [49] D. A. Tomalia, V. B. M. Hall, D. M. Hedstrand, *Macromolecules* **1987**, *20*, 1167–1169.
- [50] The kinetic data were obtained by the coalescence method, where values of the rate constant ( $k_c$ ) at the coalescence temperature ( $T_c$ ) were obtained (I. O. Sutherland, *Annu. Rep. NMR Spectrosc.* **1971**, *4*, 71–235) from the approximate expression  $k_c = \pi(\Delta\nu)/(2)^{1/2}$ , where  $\Delta\nu$  is the limiting chemical shift difference (in Hz) between the exchanging proton resonances. The Eyring equation was then used to calculate  $\Delta G_c^\ddagger$  from  $k_c$  at  $T_c$ .
- [51] a) P. R. Ashton, S. E. Boyd, C. L. Brown, N. Jayaraman, S. A. Nepogodiev, J. F. Stoddart, *Chem. Eur. J.* **1996**, *2*, 1115–1128; b) M. Murat, G. S. Grest, *Macromolecules* **1996**, *29*, 1278–1285.
- [52] Molecular simulations were carried out using the AMBER forcefield, as implemented in MacroModel (V.5.0),<sup>[53]</sup> running on a Silicon Graphics Indigo2 Workstation. The dendrons were assembled within the MacroModel INPUT submode and then fully minimized (final gradient  $< 0.5 \text{ kJ } \text{Å}^{-1}$ ) by means of the Polak Ribiere Conjugate Gradient (PRCG) algorithm with extended cut-offs. Solvation was included in the form of the GB/SA solvation model for  $\text{CHCl}_3$ . The individual dendron units were then attached to the central core and the angle between the dendron and the core was adjusted manually to minimize steric clashes between separate dendrons. The whole assembly was then fully minimized by the above method (final gradient  $< 0.5 \text{ kJ } \text{Å}^{-1}$ ). Simulated annealing, using stochastic molecular dynamics (SD) was performed within MacroModel. The system was allowed 20 ps of equilibration time at 300 K (timestep 1.5 fs), before being cooled to 50 K over 100 ps to afford a structure different from the starting geometry. This structure was then fully minimized (AMBER\*, PRCG, extended cut-offs, GB/SA solvation) until the RMS deviation was  $< 0.5 \text{ kcal } \text{Å}^{-1}$ . Structures used to describe conformations of the dendrimers at 300 K were taken from the end of the 20 ps equilibration period. Radii of the dendrimers were measured from within CSC Chem3D pro by the averaging of about ten core-to-surface distances.
- [53] F. Mohamadi, N. G. J. Richards, W. C. Guida, R. Liskamp, M. Lipton, C. Caufield, G. Chang, T. Hendrickson, W. C. Still, *J. Comp. Chem.* **1990**, *11*, 440–467.
- [54] The sixth-generation contains 63 double-branched building blocks, 21 times the number (3) in the second-generation dendrimer. The sixth-generation dendrimer has three times the radius of the second-generation dendrimer, however, giving it 27 times the available volume in which to accommodate only 21 times the number of moieties.
- [55] The ninhydrin reagent was prepared with ninhydrin (0.3 g) and glacial acetic acid (3 mL) in *n*-butanol (100 mL).
- [56] The cerium reagent was prepared with phosphomolybdic acid (2.5 g), cerium(IV) sulfate (1.0 g), and sulfuric acid (6 mL) in water (100 mL).